



**75 G SERIES**



# KIP 75 G Series **User Manual**

Thank you for purchasing the Multi-Function Printer KIP 75 Series.

This Hardware Operation Guide contains functional and operational explanations for the KIP 75 Series.

Please read this Hardware Operation Guide carefully before using the printer.

Please keep this Hardware Operation Guide for future reference.

## **1. When this product is installed in North America.**

This product complies with part 15 of the FCC Rules. Operation is subject to the following two conditions: (1) This product may not cause harmful interference, and (2) this device must accept any interference received, including interference that may cause undesired operation.

### **FCC CAUTION**

Changes or modifications not expressly approved by the party responsible for compliance could void the user's authority to operate the product.

Note: This product has been tested and found to comply with the limits for a Class A digital equipment, pursuant to part 15 of the FCC Rules. These limits are designed to provide reasonable protection against harmful interference when the product is operated in a commercial environment. This product generates, uses, and can radiate radio frequency energy and, if not installed and used in accordance with the instruction manual,, may cause harmful interference to radio communications. Operation of this product in a residential area is likely to cause harmful interference in which case the user will be required to correct the interference at his own expense.

This product complies with Part 15 of FCC Rules and Industry Canada licence-exempt RSS standard(s). Operation is subject to the following two conditions: (1) this product may not cause interference, and (2) this product must accept any interference, including interference that may cause undesired operation of this product.

Le présent appareil est conforme aux la partie 15 des règles de la FCC et CNR d'Industrie Canada applicables aux appareils radio exempts de licence. L'exploitation est autorisée aux deux conditions suivantes : (1) l'appareil ne doit pas produire de brouillage, et (2) l'utilisateur de l'appareil doit accepter tout brouillage radioélectrique subi, même si le brouillage est susceptible d'en compromettre le fonctionnement.

Contains FCC ID: VP8-13551

Contains IC: 7391A-13551

## **2. When this product is installed in Europe**

This product complies with the requirements in CISPR 32 for a Class A computing equipment. Operation of this product in a residential area may cause unacceptable interference to radio and TV reception requiring the operator to take whatever steps are necessary to correct the interference.

**Do not install product around other electronic equipment or other precision instruments. Other equipment may be effected by electrical noise during operation.**

**If the product is installed near other electronic equipment, such as a TV or a radio, interference to said equipment, such as noise or flickering, may occur.**

**Use a separate power line and install the PRINTER as far as possible from said equipment.**

KIP 75 Series is an ENERGY STAR qualified Wide Format Printer / MFP equipment.



The International ENERGY STAR® Office Equipment Program is an international program that promotes energy saving through the penetration of energy efficient computers and other office equipment. The program backs the development and dissemination of equipment with functions that effectively reduce energy consumption. It is an open system in which business proprietors can participate voluntarily. The targeted products are office equipment such as computers, monitors, printers, facsimiles, copiers, scanners, and multifunction devices. Their standards and logos are uniform among participating nations.

The symbol shown indicates that this product conforms to Directive 2012/19/EU of the European Parliament and the council of 4 July 2012 on waste electrical and electronic equipment (WEEE) and does not apply to countries outside of EU.



Only For EU Member States

Das Gerät ist nicht für die Benutzung am Bildschirmarbeitsplatz gemäß BildschirmV vorgesehen.

The symbol shown indicates that this product conforms to SJ/T11364-2006 of People's Republic of China Electronic Industry Standard and does not apply to countries outside of People's Republic of China.



The symbol shown indicates that this product conforms to GB 18455-2001, SJ/T 11364-2006 of National Standard of the People's Republic of China and does not apply to countries outside of People's Republic of China.

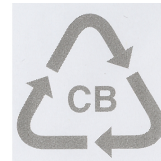

The product shown with available options. May vary from the actual product.

# Safety Warning

The following warnings are very important in order to safely use this product. These notes are important in preventing danger to the operator or operation of the printer.

The following symbols are found throughout the USER'S Manual and have the following meaning:



## WARNING

This WARNING mark means that there is a possibility of death or serious injury if you ignore or do not follow the said instruction.



## CAUTION

This CAUTION mark means that there is a possibility of injury or physical damage if you ignore or do not follow the said instruction.

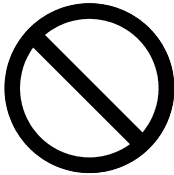

When marked with this symbol, "DO NOT ATTEMPT".



When marked with this symbol, "pay close attention to".



There are extremely hot parts inside.  
Do not touch any parts, or you will be burnt.





# WARNING

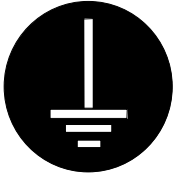

Ground the product with a correct ground source or you may be electrically shocked.



1. The Power source should be as follows:  
220 to 240V plus 6% or minus 10%, 50/60Hz, 16A or higher
2. Use a circuit with a dedicated breaker.
3. Install the product as close to the wall outlet as possible.
4. If you wish to move the printer, please contact your service personnel.



1. Do not remove the screw and do not open the cover if not instructed to do so in this User's Manual. If you ignore this warning, you may be burnt or receive an electric shock due to a hot item or electrically charged part inside of the printer.
2. Do not disassemble or tamper with the printer.  
It may result in a fire or an electrical shock.

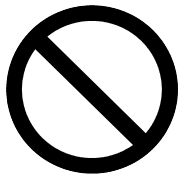

1. Do not plug in the printer into a multi-wire connector in which some other equipment is plugged into.  
It may cause a fire due to outlet overheating.
2. Do not damage the Power Cord by stepping on or placing heavy items on it.  
If the Power Cord is damaged, it may cause a fire or you may receive an electric shock. **REPLACE THE CORD IF DAMAGED!**

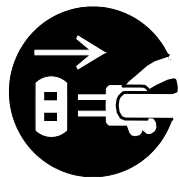

1. Do not put a flower vase, a flowerpot or any water-filled item on the product.  
Spilt water could cause a fire or an electric shock.
2. If the product generates an abnormal smell or noise, turn it off and unplug it from the wall electrical outlet immediately.



Do not throw the toner into a fire or other sources of heat, as it can explode.



# CAUTION

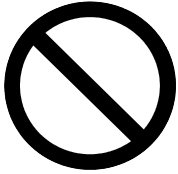

1. Do not install the printer in a humidified room or a dusty room. Also, do not install the printer on an unstable floor as injuries may occur.
2. This equipment is not suitable for use in locations where children are likely to be present.

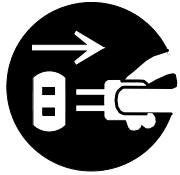

1. Unplug the printer before you move it.  
The power cord may be damaged and it may result in a fire or electric shock.
2. If you do not use the printer for a long duration (holidays, company shutdown) turn off and unplug the printer from the outlet for safety.

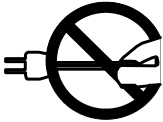

Do not pull the cord when you unplug the printer as you may damage the Power Cord.



There are hot items inside of the printer.  
Take great care not to touch these items when you remove mis-fed media.



Ventilate the room well if you print in a small area.

## POWER CORD INSTRUCTION

The installation of (or exchange to) a power plug which fits in the wall outlet of the installation location shall be conducted in accordance with the following:



### **WARNING**

Select a power plug which meets the following criteria;

- The plug has a voltage and current rating appropriate for the product's rating marked on its name plate.
- The plug meets regulatory requirements for the area.
- The plug is provided with a grounding pin or terminal.

If the appropriate plug does not fit the wall outlet in the installation, the customer shall install an appropriate outlet.

Connector Type:

Configuration	Standard	Rating	Usually found in
	IEC60320:C19	20A 250V (UL) 16A 250V (IEC)	

Plug Type: Model Rating 220-240V

Configuration	Standard	Rating	Usually found in
	NEMA6-20	20A 250V	North America (UL Listed)
	CEE7/7	16A 250V	European countries
	KS C 8305	16A 250V	Korea
	AS/NZS 3112	16A 250V	Australia New Zealand
	GB1002 GB2099.1	16A 250V	China
	IRAM 2073	16A 250V	Argentina

Cord Type

Standard	Rating	Usually found in
SJT 3X12AWG Long <4.5m	20A 250V	North America (UL Listed)
HO5VV-F 3X1.5mm <sup>2</sup>	16A 250V	European countries Argentina
RVV 3X1.5mm <sup>2</sup>	16A 250V	China

# Chapter 1

## Before Use

	Page
<b>1.1 Installation Requirements</b> .....	1- 2
<b>1.2 Originals Prohibited from Duplication</b> .....	1- 3
<b>1.3 Features</b> .....	1- 4
<b>1.4 Specifications</b> .....	1- 5
1.4.1 General .....	1- 5
1.4.2 Printer Part .....	1- 6
1.4.3 Scanner part (for MFP Model) .....	1- 8
<b>1.5 Appearance</b> .....	1- 9
1.5.1 Front view .....	1- 9
1.5.2 Rear view .....	1-10
<b>1.6 Specifications for Scan Original (for MFP Model)</b> .....	1-11
1.6.1 Original - Standard .....	1-11
1.6.2 Special Documents .....	1-11
1.6.3 "Do Not Scan" Originals .....	1-12
<b>1.7 Specifications for the Printing Media</b> .....	1-15
1.7.1 Papers not available to use .....	1-15
1.7.2 Keeping the paper in the custody .....	1-16

# 1.1 Installation Requirements

The following conditions are required for installation of the equipment.



1. POWER SOURCE should be rated as follows.  
220V to 240V plus 6% or minus 10%, 50/60Hz, 16A or higher
2. The equipment must be on an exclusive circuit.
3. The outlet must be near the equipment and easily accessible.



1. Make sure to connect this equipment to a grounded outlet.
2. For PLUGGABLE EQUIPMENT, the socket-outlet shall be installed near the equipment and shall be easily accessible.

The site temperature range = 10 to 32 degrees Centigrade, with the humidity between 15% to 85% RH. (NON CONDENSING)

Keep the printer away from water sources, boilers, humidifiers, refrigerators or kerosene (oil) stove.



1. The installation site must not have open flames, dust or ammonia gases.
2. The equipment must not be exposed to the air vents from air conditioners.  
It may affect the image quality.
3. The equipment should not be exposed to the direct sunlight.  
Please draw curtains to block any sunlight.  
When you open the Movable Unit, do not expose the Photoconductive Drum to strong (intense) light as this will damage the Drum.



Ozone will be generated while this equipment is use, although the quantity generated is within safe levels. (see certifications)  
Ventilate the room, if required.

Keep ample room around the equipment to ensure comfortable operation.  
(Refer to the following figure.)

The equipment must be leveled and the floor strength must be ample to sustain the weight of the equipment.

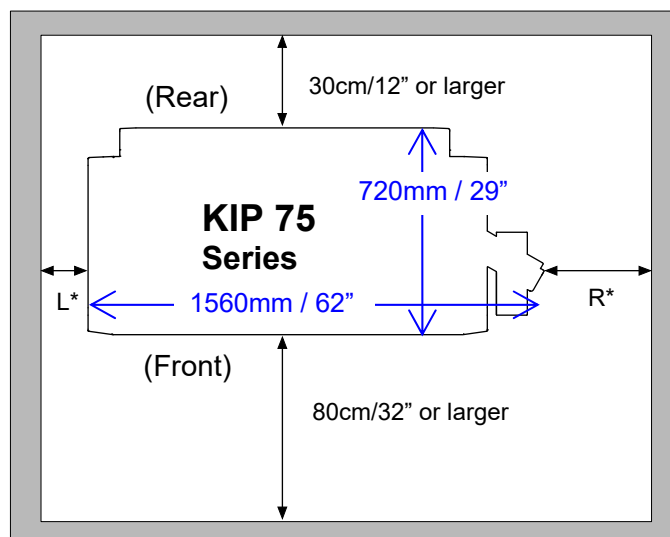

\* L + R = 35cm/14" or larger  
(R must be larger than L)  
(L = 5cm/2" or larger recommended)

# 1.2 Originals Prohibited from Duplication

It is not necessarily allowed to copy every kind of original.  
You may be punished by the law if only you possess the copy of some kind of original.  
We recommend you to consider enough before you copy such original.

[Originals prohibited from copying by the law]

1. It is not allowed to copy Currency (Bill, Money, Bank Note, etc.), Government issued Negotiable Instruments (National Bonds, Security, Local Debt Bonds, etc.).
2. It is not allowed to copy Foreign Currency or Foreign Negotiable Instruments.
3. It is not allowed to copy unused postal stamps or government postcards without permission to make replica from Government.
4. It is not allowed to copy Government issued revenue stamps, certificate stamps which are prescribed by Liquor Tax Act or the Commodity Tax Act.

[Special items to be cared]

1. It is warned by the government to copy private issued securities (stock certificate, draft, check, goods ticket, etc.), commutation ticket or book of tickets, excluding that some specific company copies such originals as many as it requires for its own business.
2. We recommend you not to copy freely such originals as government issued passport, public or private issued licenses, automobile inspection certification, IDs and tickets like pass or meal.

Reference Law	Prohibited items to copy
Regulations to control fake currency and Bond.	Currency (Bill, Money, Bank Note, etc.), Government issued Negotiable Instruments (National Bonds, Security, Local Debt Bonds, etc.)
Control Law against Forged & faked Foreign Currency, Bill, Bank Note and Bond	Foreign Currency or Foreign Negotiable Instruments
Forged postal stamps control law	Unused postal stamps or government postcards
Forged revenue stamps control law	Government issued revenue stamps, and certificate stamps prescribed by Liquor Tax Act or Commodity Tax Act
Currency similarity securities Control Law	Private issued securities (stock, draft, check, goods ticket, etc.), commutation or book tickets

[Originals protected by the copyright]

It is prohibited to copy such originals as book, music, paintings, printed copy, maps, drawings, movie and pictures which are protected by the copyright, except for personnel or family use or similar purpose.

# 1.3 Features

---

- (1) KIP 75 Series is an Electro Photographic wide format LED printer/MFP.  
Advanced drivers and comprehensive print utilities make the KIP 75 Series an advanced, easy to use system. (some functions may be optional)
- (2) Selection from 4 models are available according to the requirement.
  - 4 rolls wide format MFP model
  - 4 rolls wide format printer model
  - 2 rolls wide format MFP model
  - 2 rolls wide format printer model
- (3) KIP HDP technology generates no waste toner.
- (4) The KIP HDP Plus imaging system produces high definition lines, distinctive greyscale and consistent blacks.
- (5) Density Compensation Process provides consistent image density in various environments.
- (6) The maximum paper width is 36" (914mm) wide, and the minimum is 11" (279mm).  
The maximum paper length is 6m (with 36" paper) or, and the minimum is 8.5" (210mm).
- (7) Flange type loading mechanism eases operator's media loading work.
- (8) Up to 600dpi print resolutions with an enhanced scanning system produces the highest quality images controlled by an advanced KIP Image Process System.
- (9) Easy access to USB port allows users to provide efficient productivity by using "File to Print" / "Scan to USB".
- (10) 2-way print delivery (front, up to 50 sheets of plain paper / rear) suits the preference of the user's print handling. (rear stacking requires a stacking device, option)
- (11) Use of optional hardware finisher devices helps handling of the finished prints.  
Available optional finisher are;
  - Auto Stacker
  - Online Folder
- (12) Contactless IC card reader for more efficient accounting management (option)
- (13) 12.1 inch multi-touch panel allows for tablet-like operation and image viewing.
- (14) KIP 75 Series has 10D / 8D models to meet various customers' printing volume.

# 1.4 Specifications

## 1.4.1 General

Subject	Specification
Model	KIP 75 Series - 2 Roll / 4 Roll - Printer / MFP
Configuration	Console
Power consumption	Maximum : 3000W or less Copy / Printing : 1500Wh (Ave.) Ready : 430Wh (Ave.)
Power consumption (Low power mode)	Conformity with International Energy Star Program.
Acoustic noise	Ready ..... Max. 50db Printing ..... Max. 57db (impulse sound excluded) <span style="float: right;">EN ISO 7779</span>
Ozone	Max. 0.05ppm (Measurement method under UL Standard)
Dimensions	MFP Model (In case of excluding UI, Tray) -1356mm (Width) x 720mm (Depth) x 1185mm (Height)  MFP Model (In case of including UI, Tray) -1560mm (Width) x 720mm (Depth) x 1580mm (Height)  Printer Model (In case of excluding UI, Tray) -1356mm (Width) x 720mm (Depth) x 1095mm (Height) Printer Model (In case of including UI, Tray) -1560mm (Width) x 720mm (Depth) x 1580mm (Height)
Weight	MFP Model -about. 281kg (620lb) (4 Roll Model)  Printer Model -about. 263.5kg (581lb) (4 Roll Model)
Environmental condition for usage	(Temperature) 10 to 32 degrees Centigrade / 50 to 89.6 F (Humidity) 15 to 85% RH
Interface	Network Interface (10 BASE-T / 100 BASE-TX / 1000 BASE-T) USB2.0 (5VDC max)
Rating	220V to 240V plus 6% or minus 10%, 50/60Hz, 13A

### NOTE

The above specifications are subject to change without notice.



## 1. 4. 2 Printer part

Subject	Specification
Printing method	LED Array Electro photography
Photoreceptor	Organic Photoconductive Drum
Print speed	10D: 10 ppm / D Landscape (100mm/s printing speed) 8D: 8 ppm / D Landscape ( 80mm/s printing speed)
Print head	LED Array
Resolution of print head	600dpi x 2400dpi
Print width	Maximum 914mm / 36" Minimum or 297mm / 11" (roll media) or 210mm / 8.5" (cut sheet)
Print length	Maximum (Standard) 6,000mm / 19.7ft for 36" / A0 wide (plain paper / bond) or "5 x Standard length" (plain paper / bond) "2 x Standard length" (tracing paper / vellum) "1 x Standard length" (film) (Option) 200,000mm  Minimum 210mm / 8.5"  <div style="border: 1px solid black; padding: 5px; margin-top: 10px;"> <p> <b>NOTE</b></p> <p>If the print is longer than the mentioned above, its image quality or the reliability of paper feeding is not guaranteed.</p> </div>
Paper feeding method	2 Roll Decks / 4 Roll Decks Manual Feeder (single cut sheet)
Warm up time	Shorter than 4 minutes (At 23°C, 60%RH, the rated voltage, and plain paper is used)
First print time	22 seconds (D Landscape, Rear Stacking) 24 seconds (A1 Landscape, Rear Stacking) (At 23°C, 60%RH, the rated voltage, and plain paper is used)
Fusing method	Heat and Pressure Rollers
Development method	Dry type non-magnetic mono-component toner

Subject	Specification
Media	(Recommended Media) US model: Bond           64g/m <sup>2</sup> to 80g/m <sup>2</sup> , US Bond (PB-20) Vellum         US Vellum (XV-20) Film            4MIL (PF-4DME) UK / EU / Asia model: Plain Paper   64g/m <sup>2</sup> to 80g/m <sup>2</sup> Diamond Plain Paper (80 g/m <sup>2</sup> ) Tracing Paper Gateway Tracing Paper (73g/m <sup>2</sup> ) Film            NSF4mil
Storage of consumables	(Toner cartridge) Store the cartridge within the temperature range from 0 to 40 degrees Centigrade and within the humidity range from 10 to 85% RH.

** NOTE**

The above specifications are subject to change without notice.

### 1. 4. 3 Scanner part (for MFP Model)

Subject	Specification
Scanning method	Contact Image Sensor (CIS) (5 pieces of A4 sized CIS)
Light source	LED (R/G/B)
Scanning speed (600 dpi, normal quality) (max)	Monochrome : 65mm/s Grayscale : 65mm/s Color : 22mm/s  NOTE : The actual speed may vary by the scan software.
Setting of original	Face up
Starting point of scan	Center
Scan width	Max: 914.4mm / 36" Min : 210mm
Scan length	Max: 6,000mm / 19.7ft (Including the margin area) Min : 210mm / 8.5" (Including the margin area)  NOTE : If the print is longer than 6,000mm, its image quality or the reliability of paper feeding is not guaranteed.
Optical resolution	600dpi
Digital resolution	200 / 300 / 400 / 600 dpi
Original transportation	Sheet through type
Transportable original thickness	Max: 1.60mm Min : 0.05mm  NOTE : Suggest to change "It does not guarantee both scan/copy image quality and original feeding reliability in case the original is non-standard size one of which thickness is 0.25mm or thicker.

#### NOTE

The above specifications are subject to change without notice.



## 1.5.2 Rear view



No.	Name	Function
1	Paper Exit Door	Open the Paper Exit Door when you remove the paper misfed inside the Fuser Unit.
2	LAN Port	Connect the LAN Cable to connect the printer to the network. (Do not connect a telephone line)
3	Breaker	It is possible to shut off supplying the AC power.
4	Inlet Socket	Connect the Power Cord here.
5	USB Port (USB 2.0)	For an optional device Service Use. 5VDC max.

# 1. 6 Specifications for Scan Original (for MFP Model)

A scan original must satisfy the following specifications.

Thickness	0.05mm to 1.60mm
Width	210mm to 914.4mm
Length	210mm to 6,000mm

NOTE :

1. Suggest to change "It does not guarantee both scan/copy image quality and original feeding reliability in case the original is non-standard size one of which thickness is 0.25mm or thicker.
2. Image quality for an original over 6,000mm in length is not guaranteed.

## 1. 6. 1 Original Standards

- (1) The width of original must range from 8.5" to 36" (210mm to 914.4mm).
- (2) The length of original must range 8.5" (210mm) to 6,000mm
- (3) The thickness of original must range from 0.05mm to 0.25mm.
- (4) The shape of original must be square, and it must be standard sized.
- (5) The type of original must belong to any of the followings.

Plain paper

Coated paper (High or middle class plain paper is coated with the paint.)

Tracing paper

Pansy Trace Paper (Both sides of the film is sandwiched between Tracing paper.)

Film

Newspaper

Cardboard paper

## 1. 6. 2 Special Documents

The following kinds of originals are "special". It is possible to scan them, **but the image quality and feed reliability are not guaranteed.**



- (1) The type of original is acceptable, but the thickness and type may not be:
  - Booklets
  - Original with a Hanger
  - Cut and Pasted originals
- (2) These original may not damage the scanner, but these types are NOT recommended:  
following ones.
  - Cloth
  - Aluminium Kent Paper

### 1. 6. 3 “Do Not Scan” Originals

It is impossible to use the following types of originals because they are likely to damage the scanner.

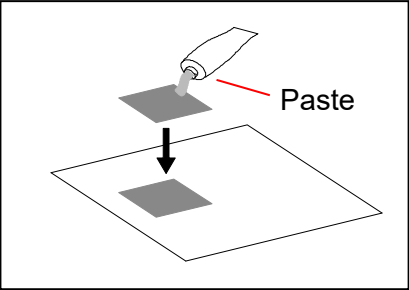
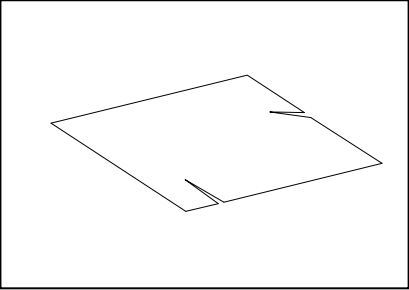
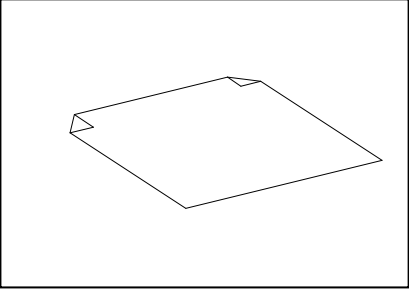
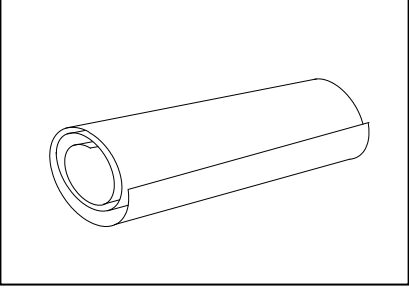
Do not scan the following kinds of original, because you may damage the original or scanner itself!

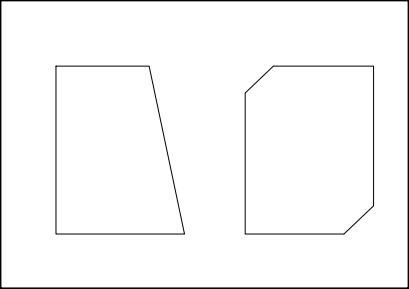
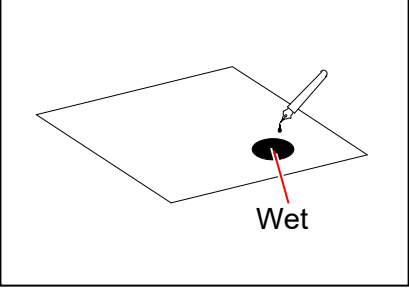
Sticked with paste	 <p>The diagram illustrates the process of sticking a piece of paper. A brush is shown applying a substance labeled 'Paste' to a small square on a larger sheet of paper. An arrow points from the brush to the paste, and another arrow points from the paste to the paper.</p>
Torn	 <p>The diagram shows a rectangular piece of paper with jagged, irregular edges, indicating it has been torn.</p>
Folded (Leading edge)	 <p>The diagram shows a rectangular piece of paper folded in half, with the leading edge (the edge closest to the scanner) clearly visible.</p>
So much curled (Diameter is smaller than 80mm.)	 <p>The diagram shows a piece of paper rolled into a tight cylinder, with the diameter of the roll being smaller than 80mm.</p>

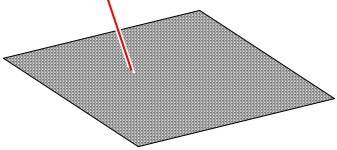
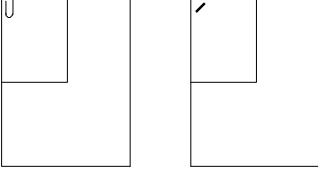
Not square	
Wet image	
Made of metal or fabric	<p data-bbox="890 801 970 835">Metal</p> <p data-bbox="1086 801 1177 835">Fabric</p> 
Rough surface (Carbon paper for example)	<p data-bbox="868 1133 1062 1167">Rough surface</p> 
Clipped or stapled	<p data-bbox="868 1451 970 1485">Clipped</p> <p data-bbox="1066 1451 1168 1485">Stapled</p> 



The following kinds of originals can be read with using a carrier sheet.

**However, the image quality and feed reliability are not guaranteed.**

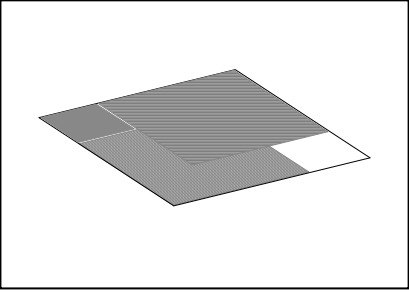
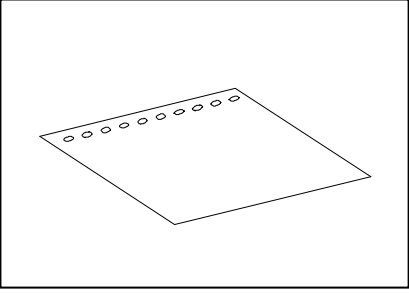
Patched	
Punched	

# 1.7 Specifications for the Printing Media

## 1.7.1 Papers not available to use

Do not use the following kinds of printing paper. Doing so may damage the print engine.

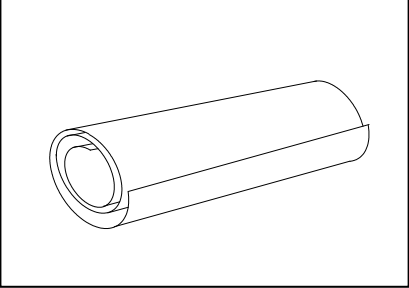
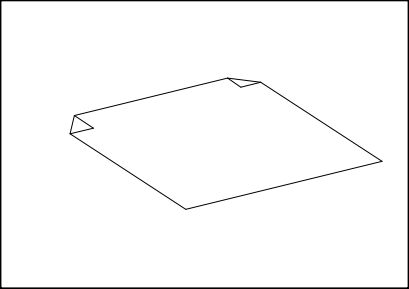
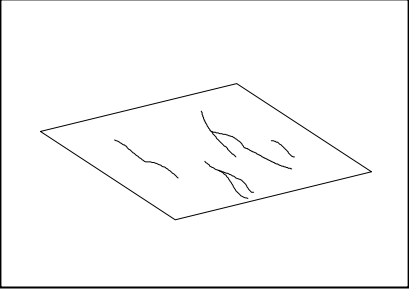
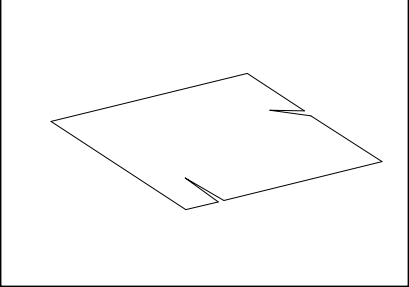
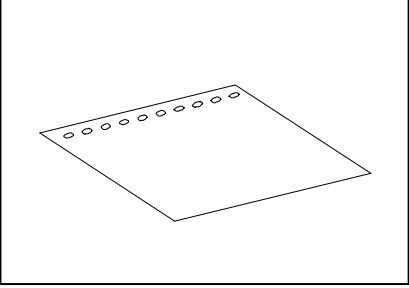
Excessively curled (a diameter of 50 mm or less)	
Folded	
Creased	
Torn	
Punched	

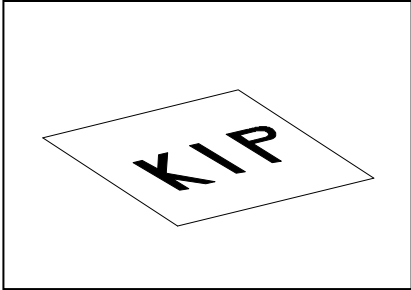
Pre-printed	
Extremely slippery	
Extremely sticky	
Extremely thin and soft	
OHP Film	

### CAUTION

Do not use the paper with staple, or do not use such conductive paper as aluminium foil and carbon paper.

The above may result in a danger of fire.

### NOTE

- (1) Print image may become light if printed on a rough surface of the paper.
- (2) Print image may become defective if the print paper has an excess curl.
- (3) It will become a cause for paper mis-feed, defective print image or paper creasing if you use a paper that does not satisfy the specification.
- (4) Do not use a paper of which surface is very special, such as thermal paper, art paper, aluminium foil, carbon paper and conductive paper.
- (5) Do not use papers with unpacked (exposed in high / low temperature & humidity) in a long period. Such papers may result in mis-feed, defective image or paper creasing.
- (6) Tracing paper exposed to air over a long period tends to cause a defective printing. Removing one round on the surface of the tracing roll paper from the beginning is recommended.  
Refer to [2.3 Replacing Roll Media].

## 1. 7. 2 Keeping the paper in the custody

Keep the paper in the custody taking care of the following matters.

1. Do not expose the paper to the direct sunlight.
2. Keep the paper away from high humidity. (It must be less than 70%)
3. Put the paper on a flat place
4. If you will keep the paper in the custody, which you have already unpacked, put it into the polyethylene bag to avoid the humidity.

# 1. 7. 3 Treatment against environmental condition

Take a necessary treatment according to the environmental condition as shown below.

Humidity(%)	Possible problem	Necessary treatment
Low ↑	“Void of image”, “crease of paper” and other problems occurs when you print with plain paper and tracing paper.	1. Install the humidifier in the room, and humidify the room air. 2. Remove the paper from the machine right after the completion of print, and keep it in a polyethylene bag.
40%	“Void of image” occurs when you print with tracing paper.	If you will not make print soon, remove the tracing paper from the machine and keep it in a polyethylene bag.
70%	“Void of image” occurs when you print with plain paper and tracing paper.	Remove the paper from the machine after everyday use, and keep it in a polyethylene bag.
High ↓	“Void of image”, “crease of paper” and other problems occurs when you print with plain paper and tracing paper.	Remove the paper from the machine right after the completion of print, and keep it in a polyethylene bag.

## ! NOTE

“Void of image” and “crease of paper” will occur in case of extremely high or low humidity.

Normal Print

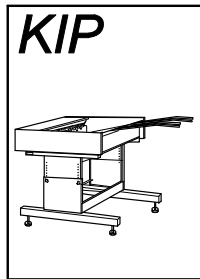

If the media is humidified;



Crease of paper

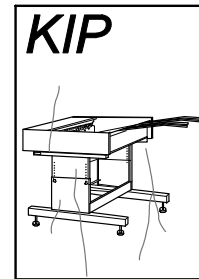

Normal Print



If the media is humidified;



Loss of image



# Chapter 2

## Basic Operation

	Page
<b>2.1 Turning on the Printer</b> .....	2- 2
<b>2.2 Turning off the Printer</b> .....	2- 4
<b>2.3 Replacing Roll Media</b> .....	2- 5
<b>2.4 Replacing Toner Cartridge</b> .....	2-11
<b>2.5 Cut Sheet Media</b> .....	2-16
<b>2.6 Copying (for MFP Model)</b> .....	2-17
<b>2.7 Stop of Scan or Copy (for MFP Model)</b> .....	2-20

## 2.1 Turning on the Printer

1. Plug the power cord for Printer into a dedicated wall outlet.

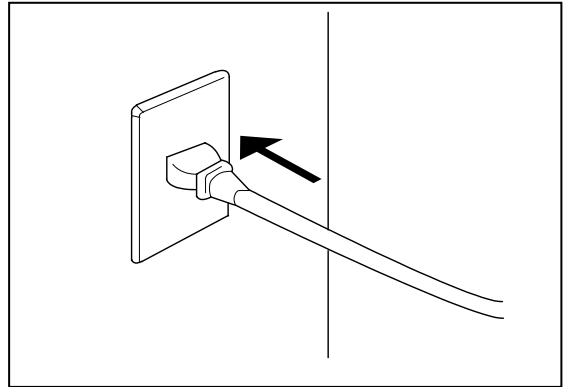

### **⚠ WARNING**

- (1) Do not handle the Power Plug with wet hands, or you may receive an electrical shock.
- (2) Make sure to earth the machine for safety.
- (3) Do not plug the printer into a multi-wiring connector in which other devices are plugged. It may overheat the outlet and may result in a fire.
- (4) The **OUTLET** must satisfy the following conditions.  
208V to 240V plus 6% or minus 10%, 50/60Hz, 16A or higher

2. Press “|” side the Power Switch on the right side of the printer to turn on the Printer.



Power Switch

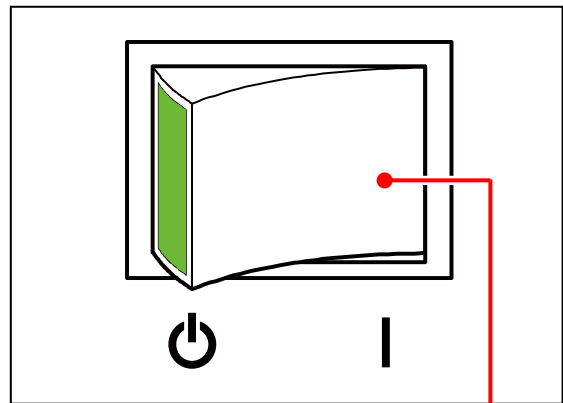

Press “|” side.

3. The User Interface (UI) starts operating, and displays the following Home Screen in one minute. "Warming Up" is displayed in the status indication while warming up.

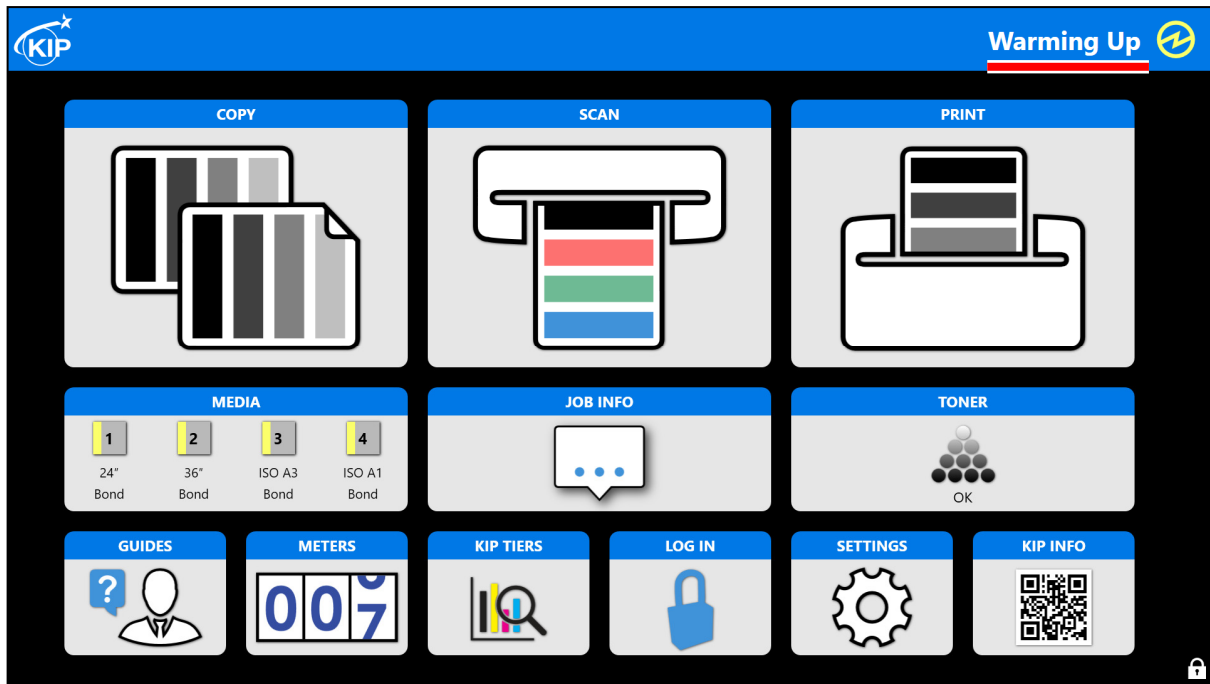

The UI screen may vary depending on your system configuration.  
(Shown with available options)

**NOTE**

It is not possible to print while displaying "Warming Up" in the status indication.

4. "Ready" is displayed in the status indication when the machine is available to print.

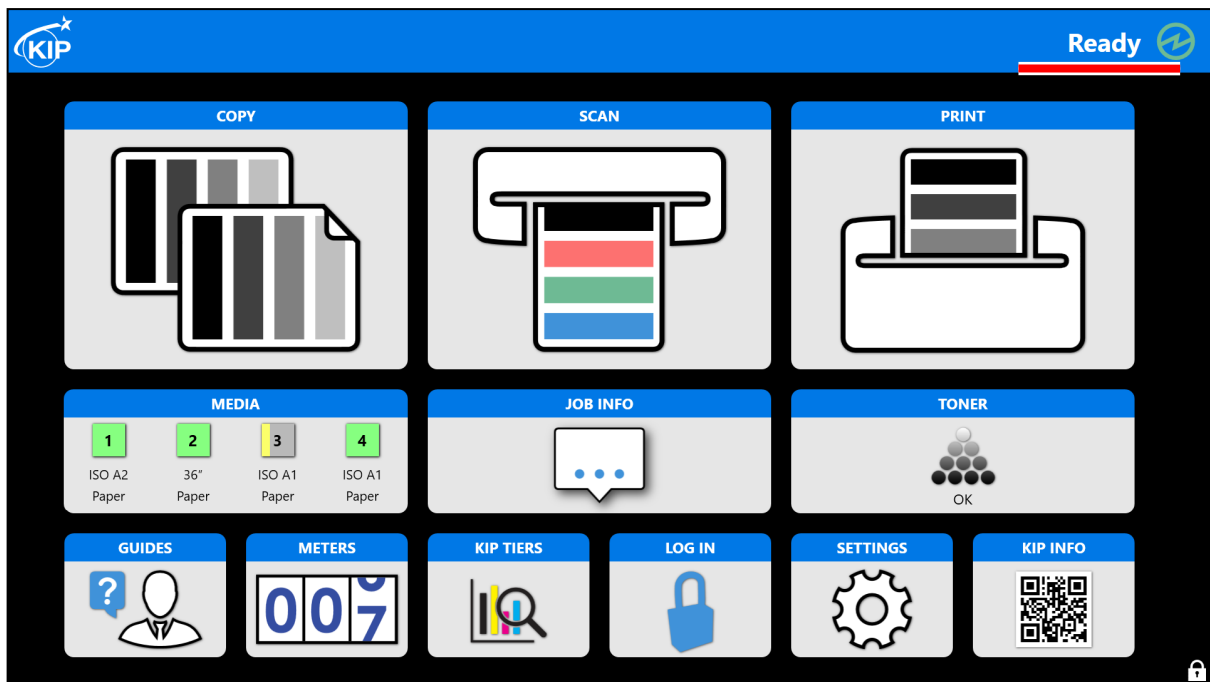

## 2.2 Turning off the Printer

1. There is a Power Switch on the right side of Printer.  
Press its “⏻” side to turn off the Printer.

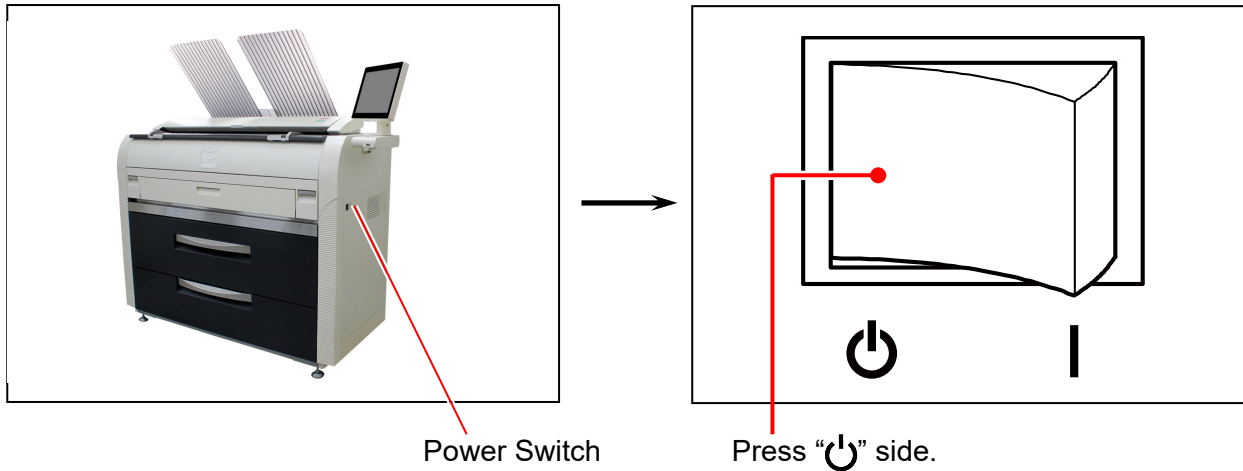

### **⚠ CAUTION**

The Printer print engine and UI appear to be shut down when you turn off Printer. However, the controller PC embedded inside the Printer is still operating and will shutdown in approximately two minutes after Power Switch operation.

Do not unplug the Printer before the controller PC completes its shutdown. Doing so may damage data or the device.



## 2. 3 Replacing Roll Media

- (1) When the printer is running out of a roll media, the UI Screen will display “Out of Paper” sign.  
Follow the later procedure (or as noted in the UI’s User Guide) to load a roll media.  
Please refer to your Touch Screen Operator’s Guide for the UI screen.
- (2) This section describes how to install a roll media to Roll Deck 1.  
The same procedure is applied to Roll Deck 2, unless otherwise noted.

### ! NOTE

- (1) A paper mis-feed tends to occur just before out of a roll paper.
- (2) A tracing roll paper is recommended to be loaded to Roll Deck 1 (front).

1. Pull the lever (1) to unlock the Roll Deck. Draw out the Roll Deck.



2. Holding both Flanges (2), lift and remove a roll media or an empty roll core (3).

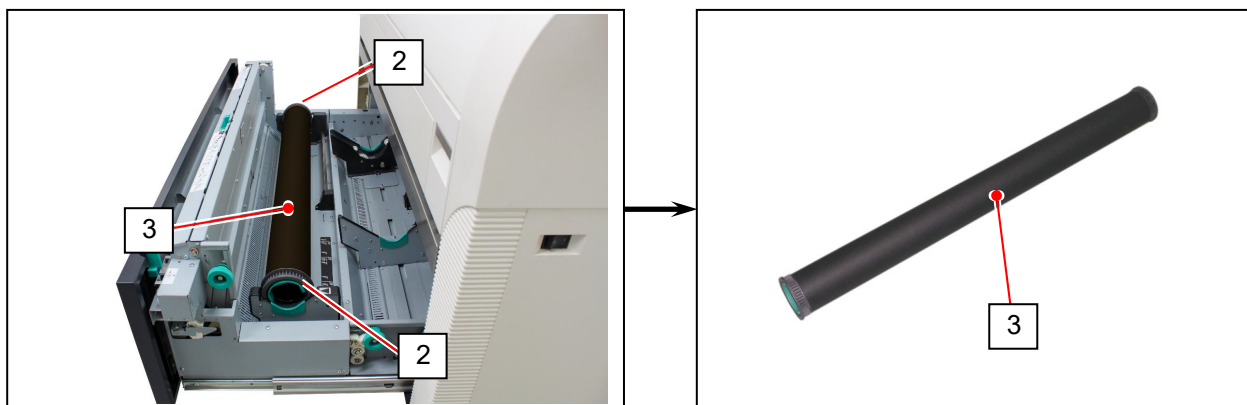

3. Raise the green lever (4) on Flange (2). Remove both Flanges (4) from the roll core (3).

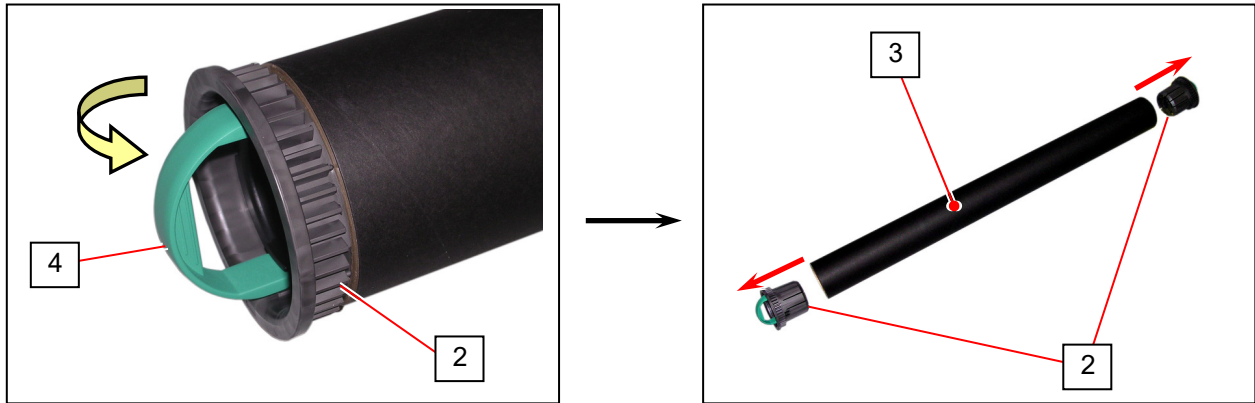

4. Move a right Slide Guide (5) to match your roll media's width.  
The right and left Side Guides will automatically move together.

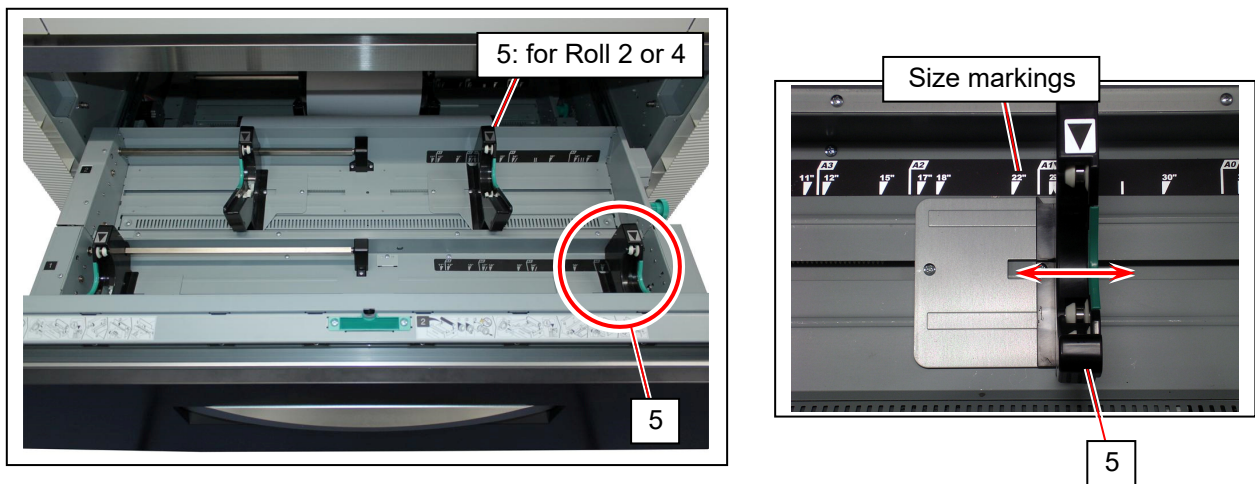

5. Insert each Flange (2) into both ends of the roll media core to be installed.

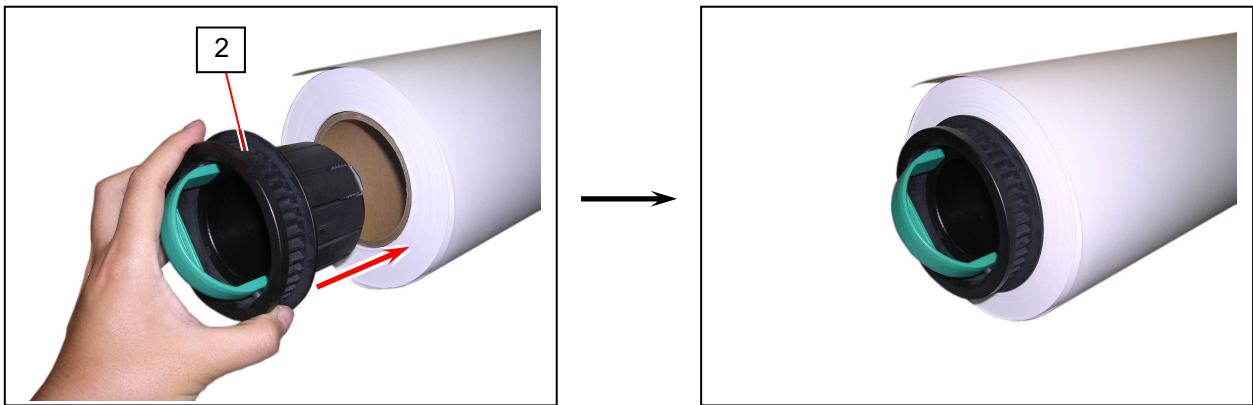

**NOTE**

(1) Fully insert Flange into the roll media core so that the inside rim of Flange evenly touches the side face of the roll media.

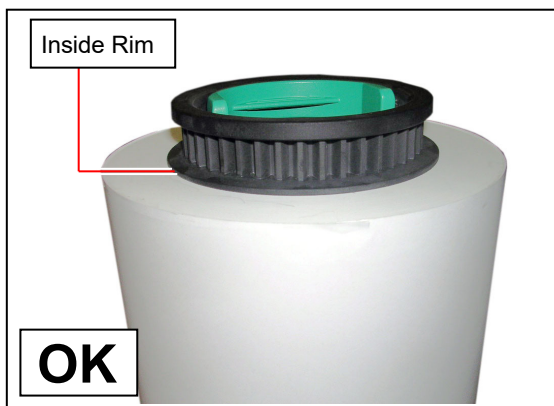

**Correct:** Fully inserted

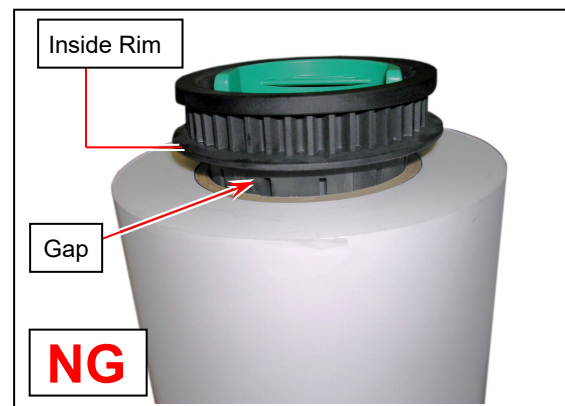

**Wrong:** not touching roll side

(2) Flange has Stoppers with sharp edge. Be sure not to touch them.

6. Push both the levers (4) down in either way. Position them flat against Flange to secure the roll media.

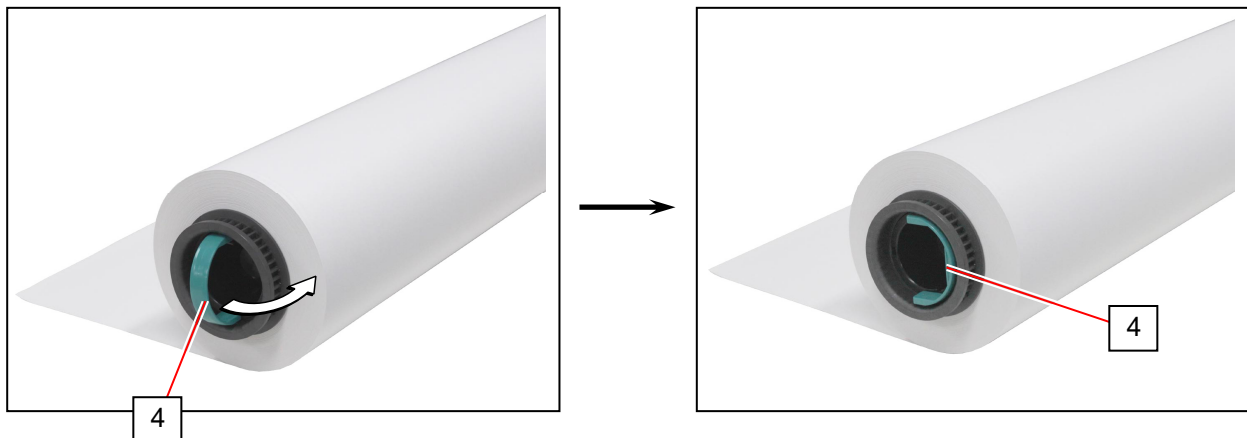

7. Lift the roll media by holding both Flanges. Lower Flanges onto Slide Guides (5) in the Roll Deck.

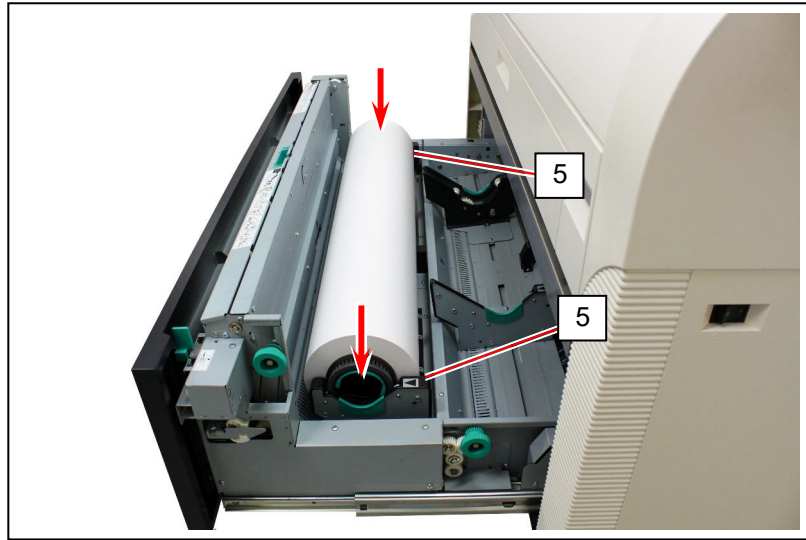

**NOTE**

(1) Be careful of the winding direction of the roll media.

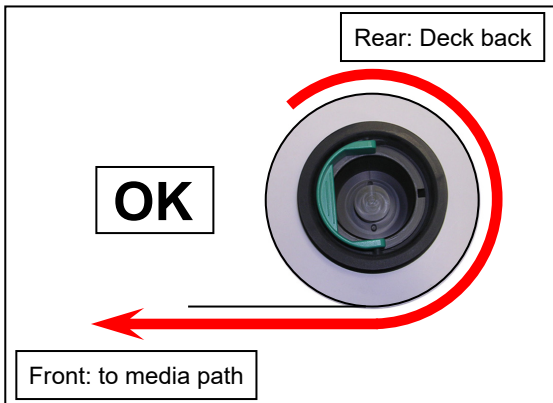

**Correct:** Edge comes from bottom

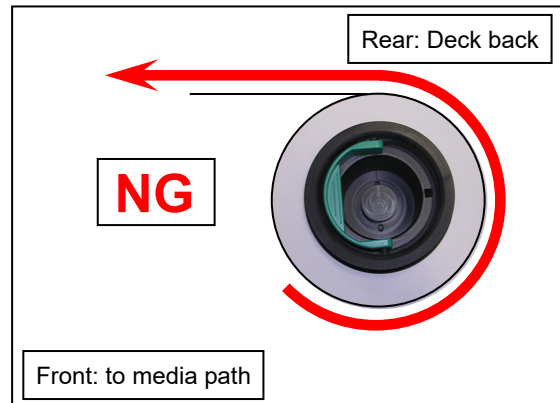

**Wrong:** Edge comes from top

(2) The outside rim (6) of Flange should meet the black triangle (7) marked on Slide Guide. Otherwise the roll media may fall in Roll Deck or result in an incorrect media feeding.

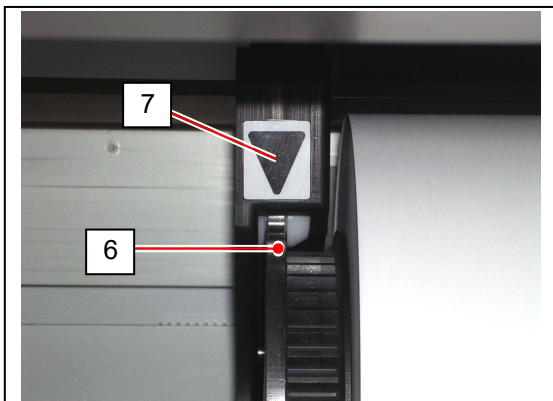

**Correct**

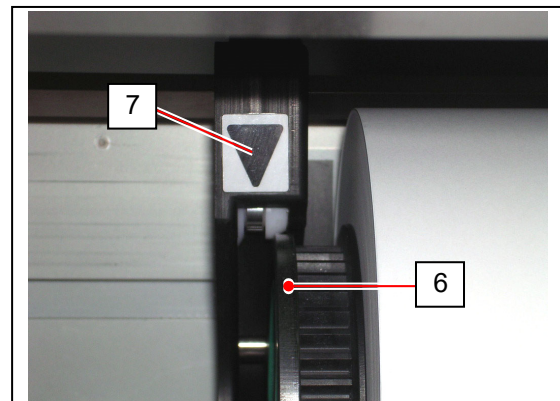

**Wrong**



8. Insert the leading edge of the roll media under Guide Plate (8) until it touches the feeding roller. Rotate Feed Knob (9) clockwise so that the feeding rollers catch the leading edge.

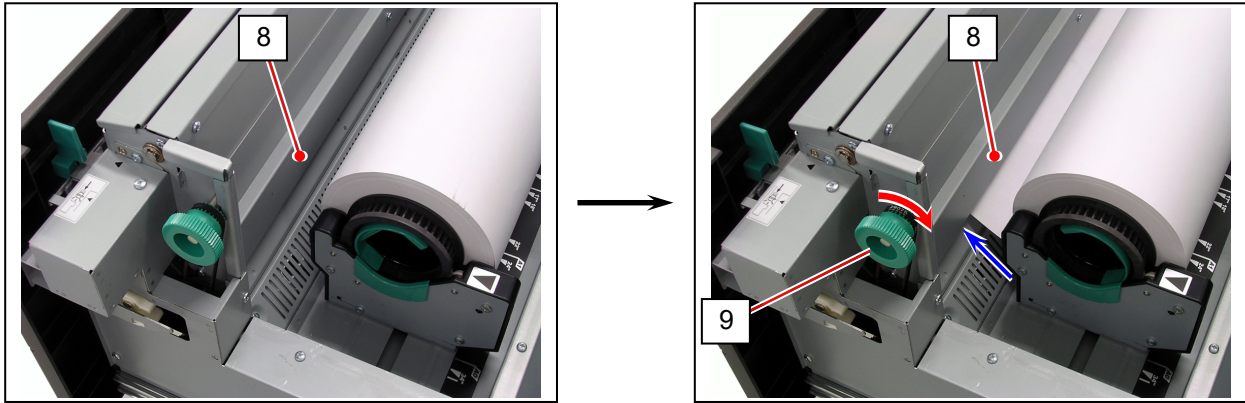

**! NOTE**

Use the rear Feed Knob (10) for Roll Deck 2 or Roll Deck 4.

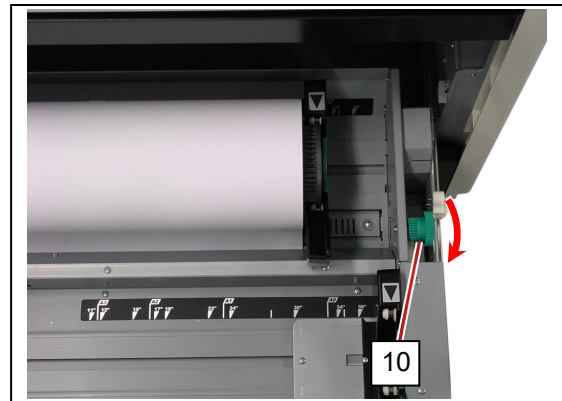

9. Hold the green grip (11: on the middle of Guide Plate) and turn Guide Plate outside. With holding, rotate Feed Knob (9) again so that the leading edge comes out in 100mm.

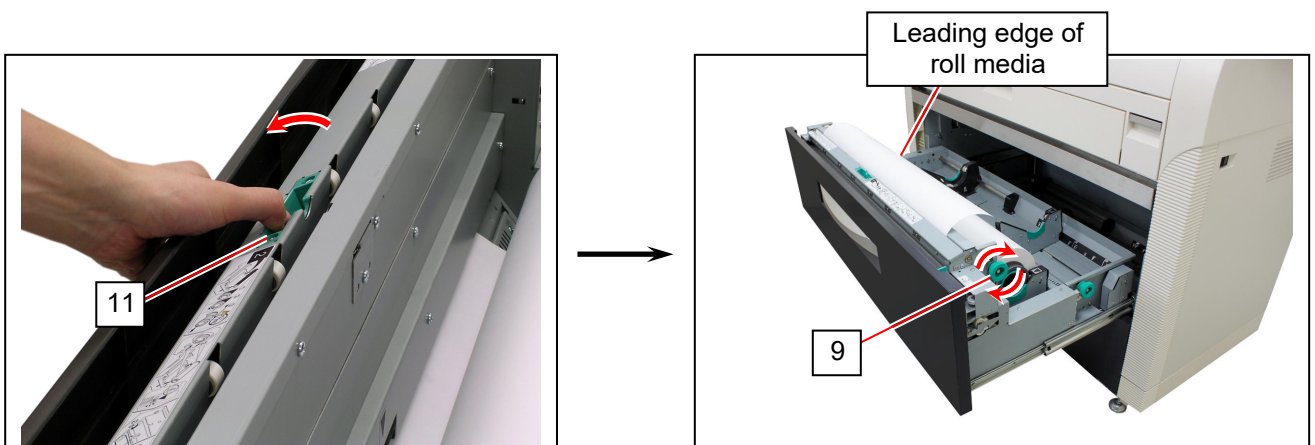

- Slide the green Cutter Knob (12) fully from either side to another to make a new straight edge. Remove the cut portion.

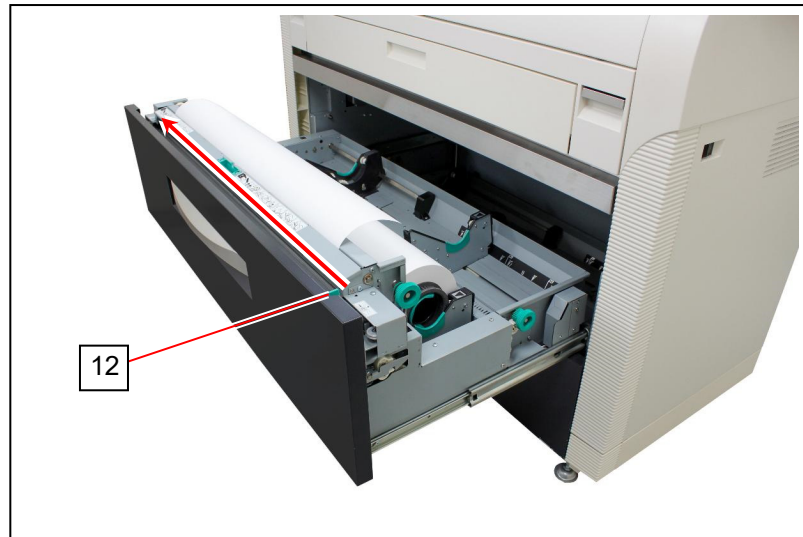

**! NOTE**

Completely slide the Cutter Knob (12) until it stops at either end. Not doing so may cause a paper jam.

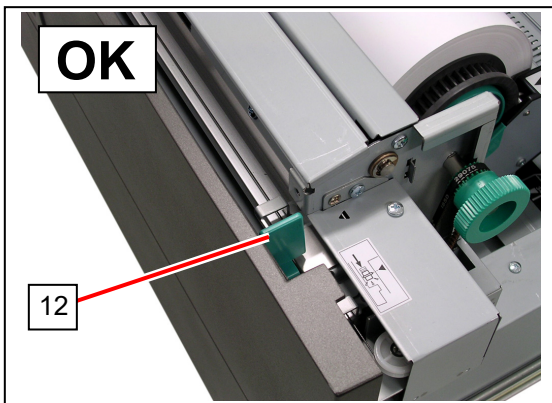

**Correct**

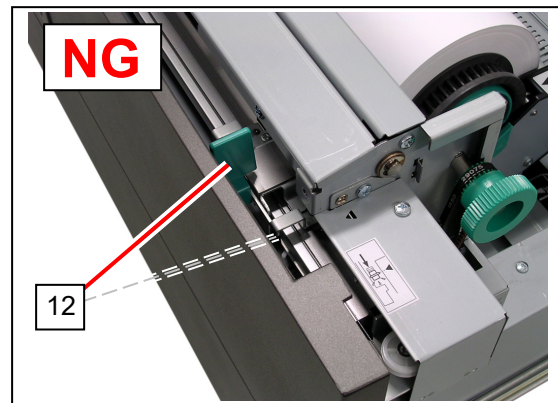

**Wrong**

- Gently close the Roll Deck.

**! NOTE**

Be sure to close the Roll Deck fully until it locks at the correct position. A paper jam may occur if it is not locked firmly.

## 2. 4 Replacing Toner Cartridge

### **⚠ WARNING**

There is combustible powder in the toner cartridge.  
Do not burn up the used toner cartridge.

### **Reference**

When the toner is empty, the UI Screen will display Toner Empty sign.  
Follow the later procedure (or as noted in the UI's User Guide) to replace the Toner Cartridge with a new one (genuine).

### **⚠ NOTE**

- (1) The Printer will indicate Toner Empty sign if an incorrect toner cartridge or no toner cartridge is installed to the printer.
- (2) At the machine's installation, some amount of initial toner powders will be supplied to the machine. Thus Toner Empty sign might appear slightly earlier for the first installed toner cartridge than usual.

1. Open the Toner Hatch (1).



- Slide the green Lever (2) to the right to unlock the Toner Cartridge.  
(Lever (2) is held automatically.)

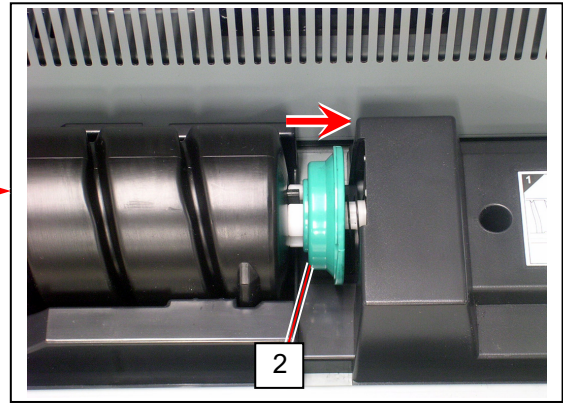

**! NOTE**

Be sure to unlock the Toner Cartridge by releasing the green Lever (2).

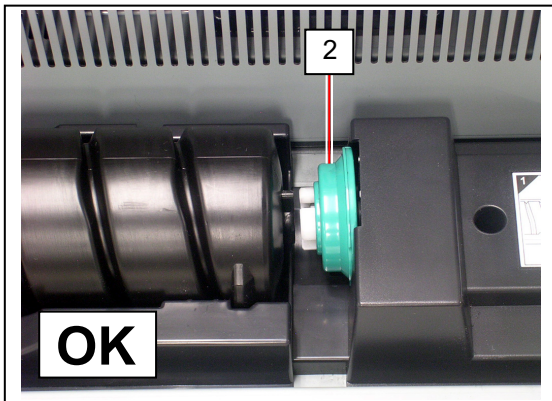

**Correct: released**  
(The green Lever (2) is shifted to the right.)

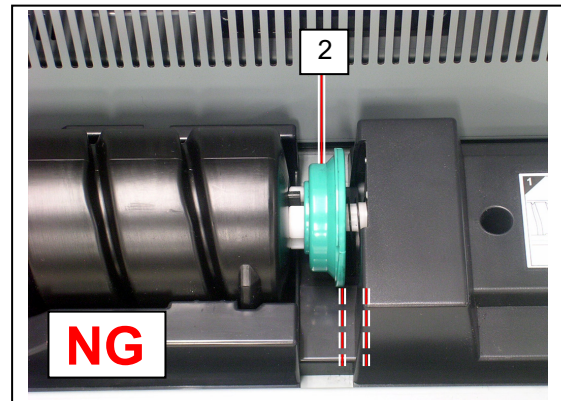

**Wrong: still engaging**



- Pressing down the Cartridge Lock Lever (3), turn the body (4) of cartridge to the arrow direction until it stops.  
(You can close the toner supply hole of the cartridge firmly by this)

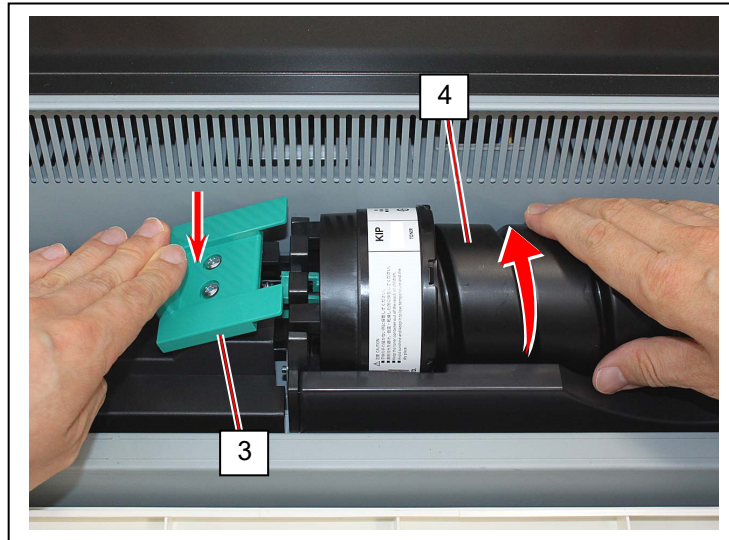

**! NOTE**

The toner may drop from the toner supply hole, and it may scattered into the machine or on the floor if you remove the Toner Cartridge without closing the toner supply hole (5).

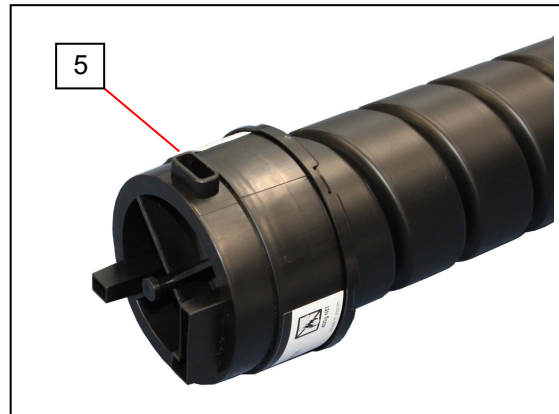

- Pressing down the Cartridge Lock Lever (3), bring up the left side of the Toner Cartridge first, and then remove the whole cartridge from the machine.

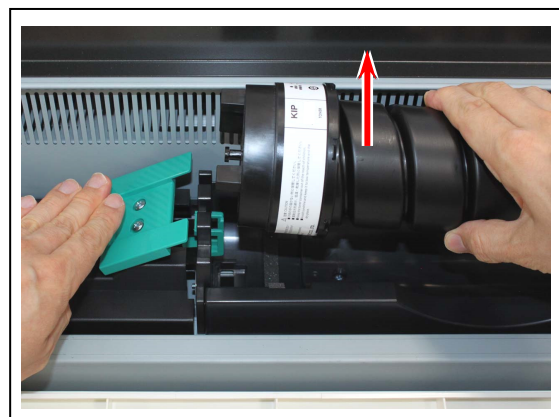
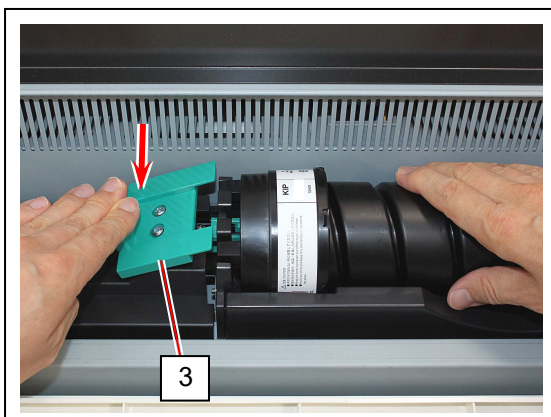

5. Shake the new Toner Cartridge left and right 5 times or more to make the toner smooth. After shaking, tilt the Toner Cartridge to the cap side.

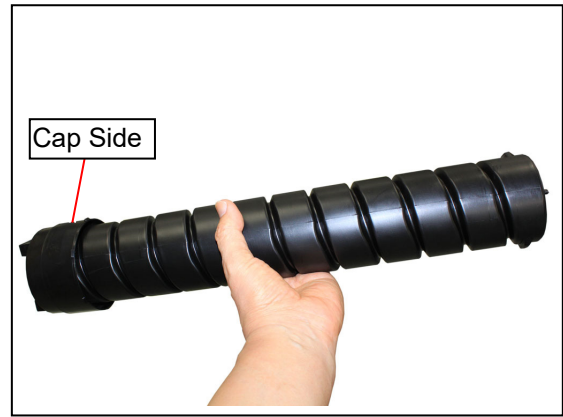
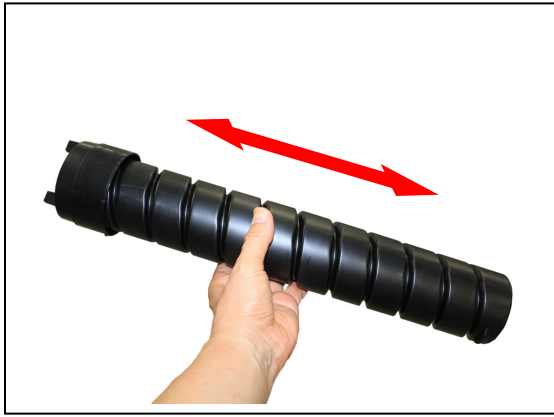

6. Keep pressing down the Cartridge Lock Lever (3). Direct the toner supply hole to the floor, fit the pin (6) on the left side of the cartridge to the groove (7) on the machine side.

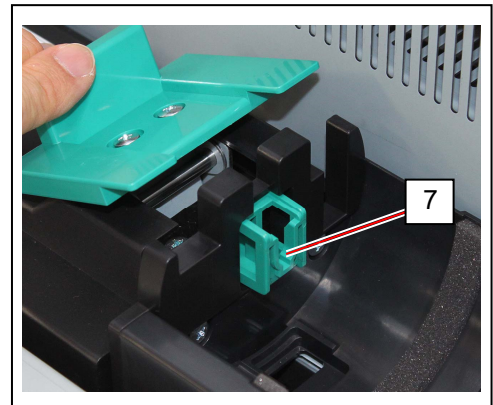
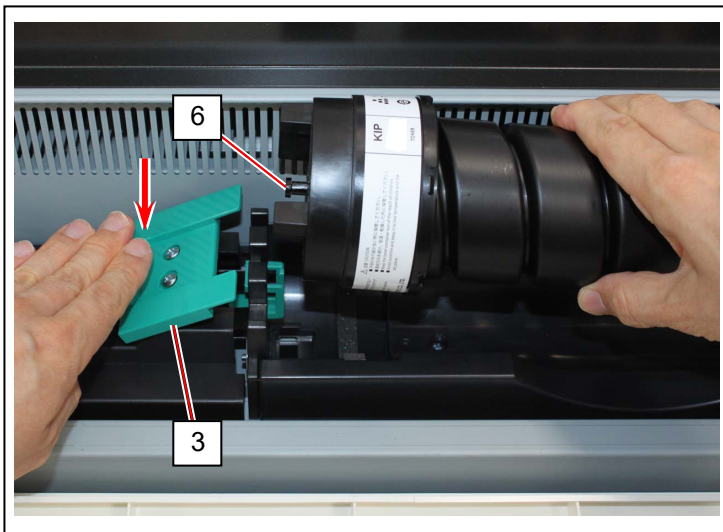

### ⚠ NOTE

Please confirm that the Cartridge Lock Lever (3) firmly locks the Toner Cartridge at the correct position. (It must be at a level position.)

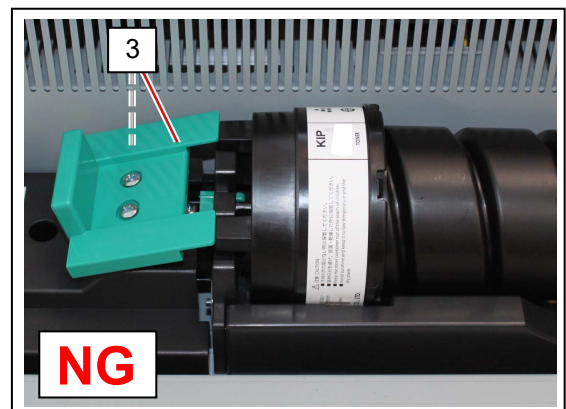
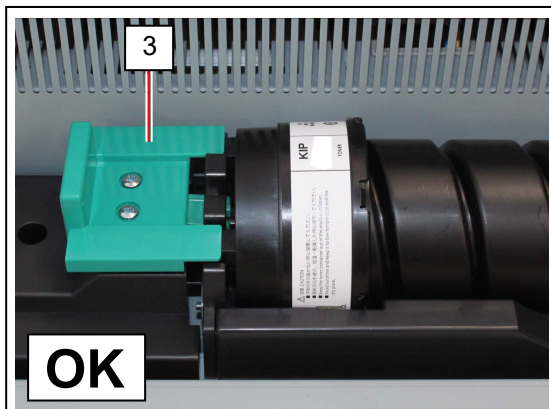

7. Turn the body (4) of the cartridge in two or more revolution to the arrow direction to open the toner supply hole. Confirm that the projection (8) is fitted into the notch (9).

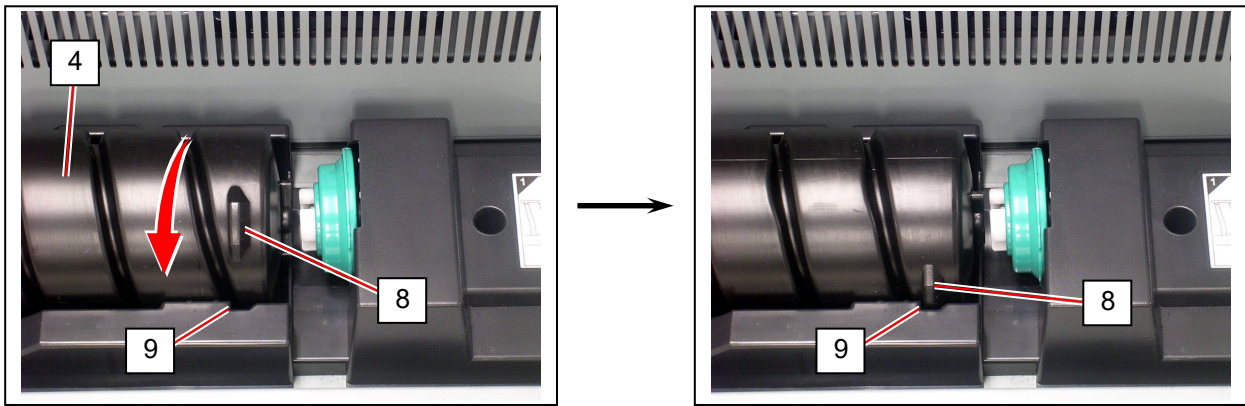

**! NOTE**

It is not necessary to lock the cartridge with the Lever (2). Lever (2) will engage on its own after closing the Toner Hatch.

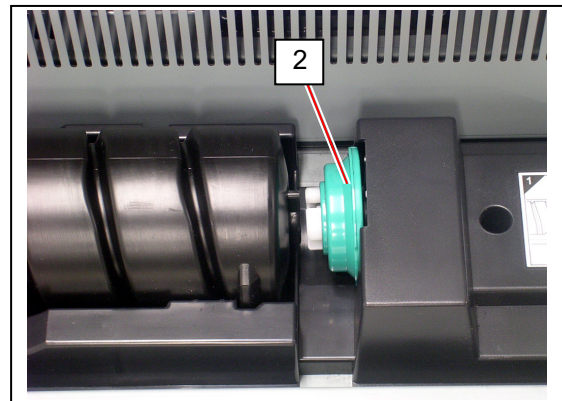

8. Close the Toner Hatch (1).

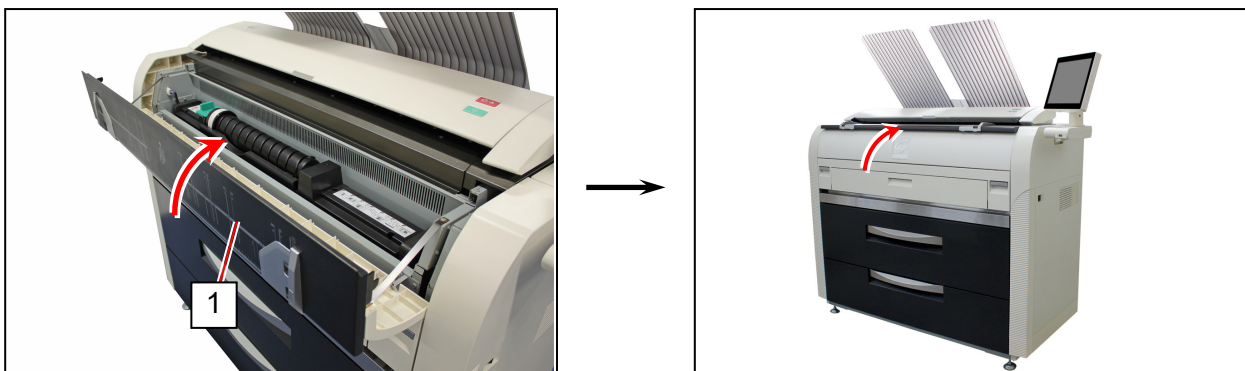



## 2.5 Cut Sheet Media

1. Open the Bypass Feeder (1).



2. There are several size markings on the table of Bypass Feeder which indicate possible feed positions. Place the cut sheet paper on the table between its concerning size markings then insert it into the Bypass Feeder. When the leading edge touches the feeding roller, the machine automatically carries and sets the paper at the proper position.

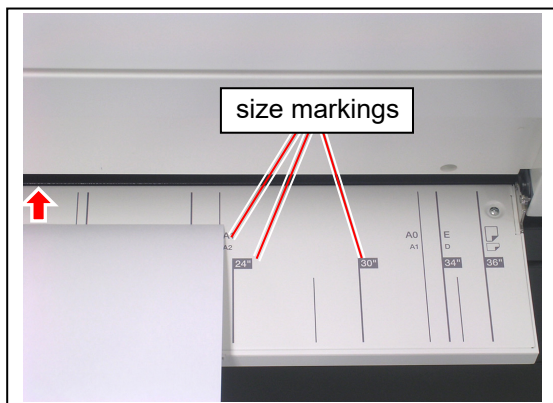

### ! NOTE

- (1) As a curly cut sheet will cause a mis-feed, straighten the sheet as far as possible before printing. And set the sheet in "curl down" direction as a mis-feed can be avoided. "Curl up" sheets tend to result in a mis-feed.



Correct (curl down)



Incorrect (curl up)

- (2) Setting a cut sheet to the Bypass Feeder while the printer is processing a print job cause a paper jam.

## 2. 6 Copying (for MFP Model)

For detailed information to make a copy, please refer to the "GUIDES" in the UI Home screen as well.

1. Press [COPY] in UI Home screen.

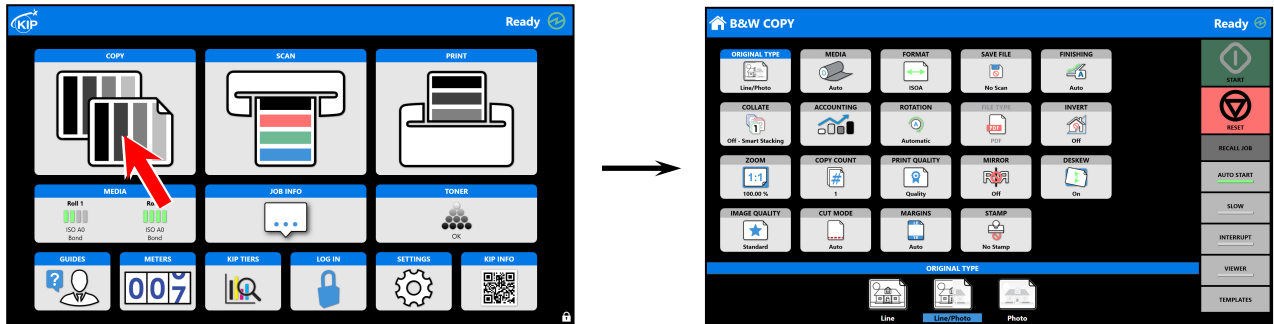

The screens may vary depending on your system configuration. Shown with available options.

2. There are several size markings on Original Table which indicate possible feed positions. Line up Original Guides with the proper markings according to the original width.

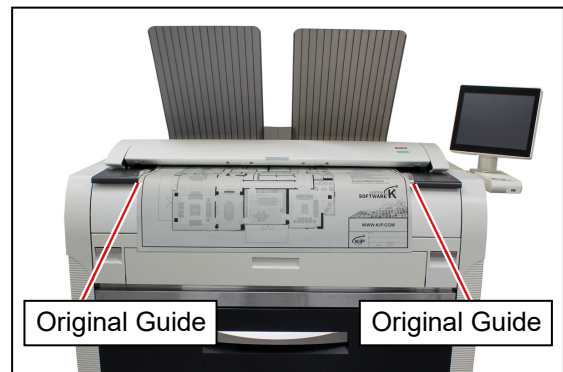

3. Place the original on the Original Table with face up. Then insert it under the Scanner Unit along with Original Guides. When the leading edge touches the original feeding roller, the machine automatically carries and sets the original at the proper position. When the original is at wait position, the LED Indicator will turn off.

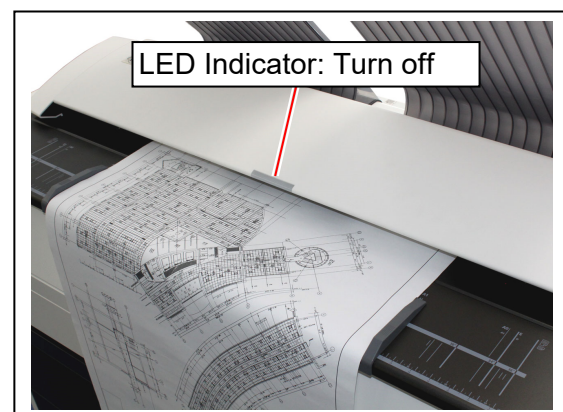
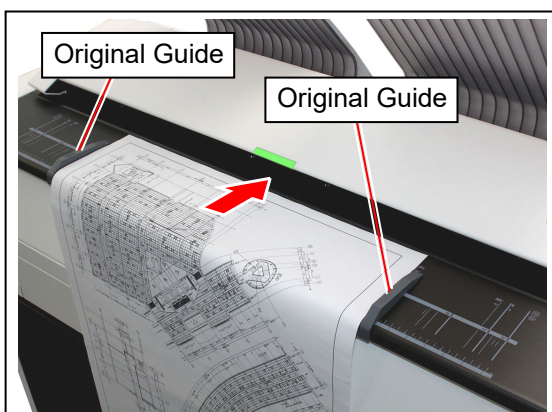

4. The Printer will start the copy process.

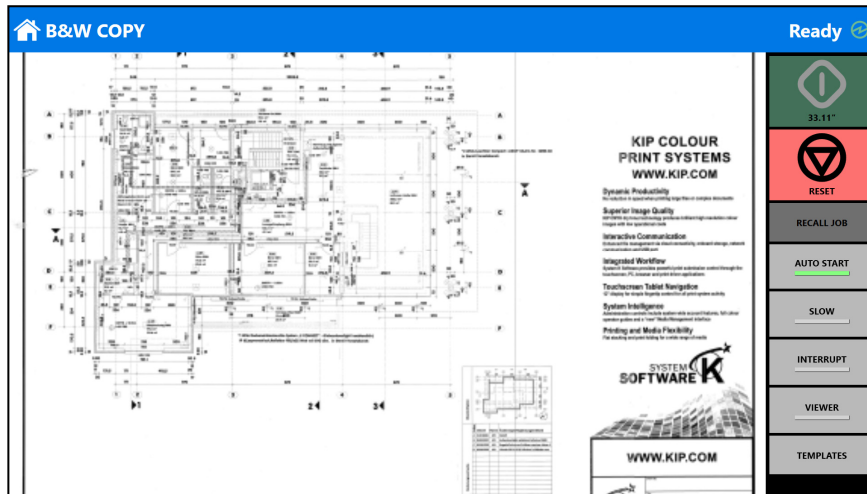

### Reference

Pressing START button may be required to start the scan according to the scanner's controller software. For further details of "Auto Start", see the software's document.

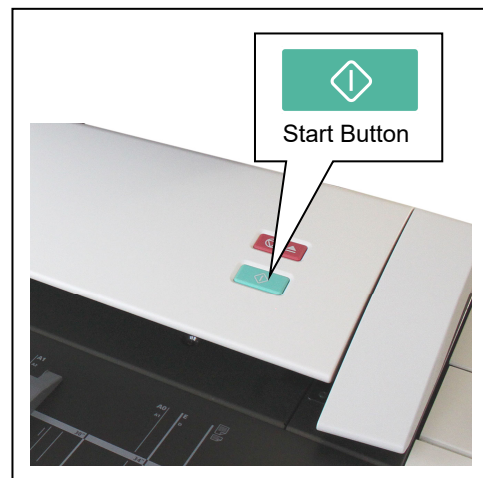

### NOTE

The scanner unit does not accept originals automatically during Sleep Mode. Tap on the UI screen and then insert an original.

The Printer has 2 print delivery system, the print tray (front, standard) / rear stacking equipment (back, option).



**NOTE**

For the front stacking, gently lift up the prints on the print tray to the arrow direction to avoid rubbing the print surface. A large number of prints should be removed in several sheets.

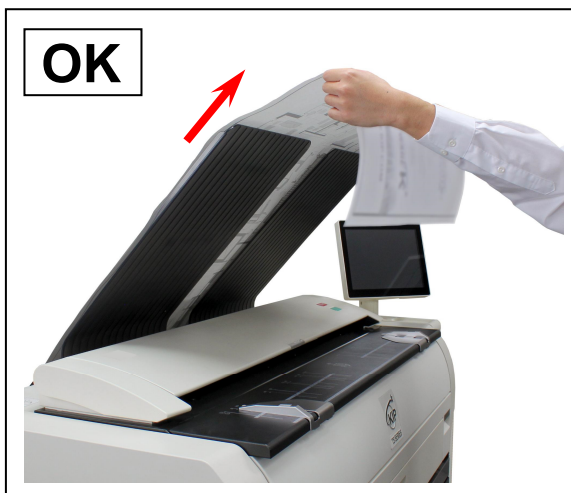

**Correct:** Gently lift up and remove



**Wrong:** Do not pull downward

For the front stacking, the printer will inform you of “Upper Bin Full” on exceeding capacity of stacking. If the UI screen shows “Upper Bin Full”, remove all the prints on the print tray.

For further information of switching front / back delivery, see the KIP Touch GUI Operator’s Guide.



## 2.7 Stop of Scan or Copy (for MFP Model)

1. If necessary, press the Scan Abort Button on the Scanner Unit to immediately stop the original while making a copy or scan. The LED Indicator flashes red.

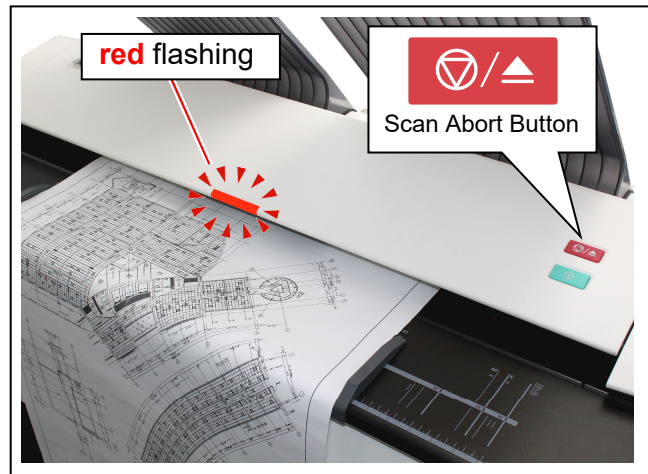

Pressing the button stops the current reading a document immediately. The current printing is stopped as well and is ejected.



### NOTE

Do not pull back or hold down the original on Original Table as an attempt to stop feeding it through Scanner Unit.

2. Lift up both sides of the Scanner Unit, and then remove a mis-fed original.
3. Gently press the Scanner Unit down and firmly close it.



# Chapter 3

## Error Correction

	Page
<b>3.1 Paper Jam</b> .....	3- 2
3.1.1 Roll Deck Section Jam (Deck 1, 2, 3, 4 Mis-feed) .....	3- 3
3.1.2 Manual Feeder Section Jam (By-Pass Mis-feed) .....	3- 6
3.1.3 Media Feed Section Jam (Registration Mis-feed, Separation Mis-feed) .....	3- 8
3.1.4 Fuser Section Jam (Exit Back Mis-feed) .....	3-10
3.1.5 Stack Jam .....	3-14
3.1.6 Original Jam (for MFP Model) .....	3-16
3.1.7 Accessory Jam .....	3-17
<b>3.2 Door Open</b> .....	3-18
3.2.1 Roll Deck (Deck 1 Open) .....	3-18
3.2.2 Engine Unit (Front Cover Open) .....	3-18
3.2.3 Paper Exit Door (Paper Exit Door Open) .....	3-19
3.2.4 Scanner Unit (Scanner feeder open) (for MFP Model) .....	3-19
<b>3.3 Other Operator Call</b> .....	3-20
3.3.1 Roll Replacement .....	3-20
3.3.2 Toner Empty .....	3-20
3.3.3 Accessory Error .....	3-20
<b>3.4 Service Call Error</b> .....	3-21

## 3. 1 Paper Jam

"xxxx Mis-feed" is displayed in the UI screen when the media is jammed. The jammed location when displaying " xxxx Mis-feed " is shown below.

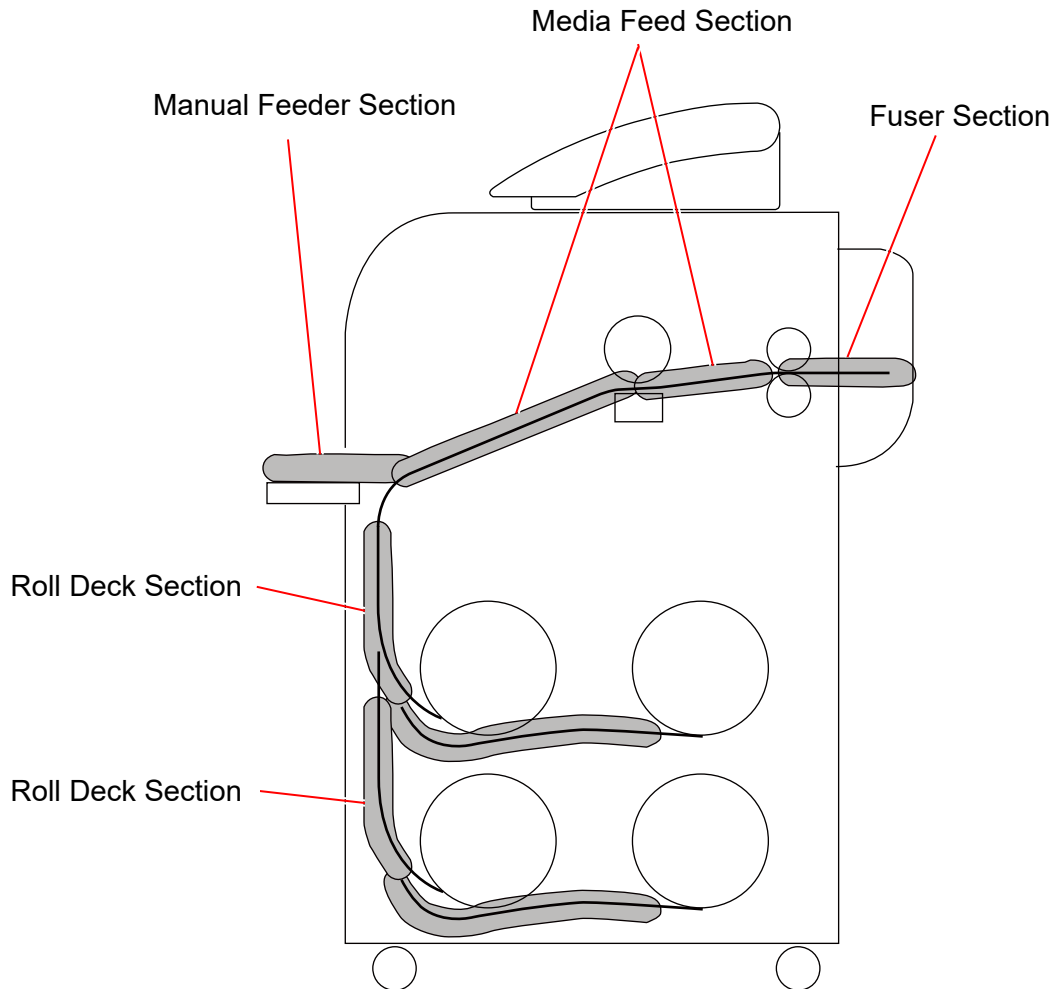

### **!** NOTE

- (1) Be careful not to get paper cuts on your hand.
- (2) Gently remove a jammed paper. When it does not reach Fuser Unit, toner on it may spill off. If toner gets into eyes or your mouth, immediately rinse them with water and contact a doctor.
- (3) Gently remove a jammed paper. When it does not reach Fuser Unit, toner on it may spill off on your cloth. Dust off your cloth. Use cold water to wash in out. Using hot water may leave a stain.

### 3. 1. 1 Roll Deck Section Jam (Deck 1, 2, 3, 4 Mis-feed)

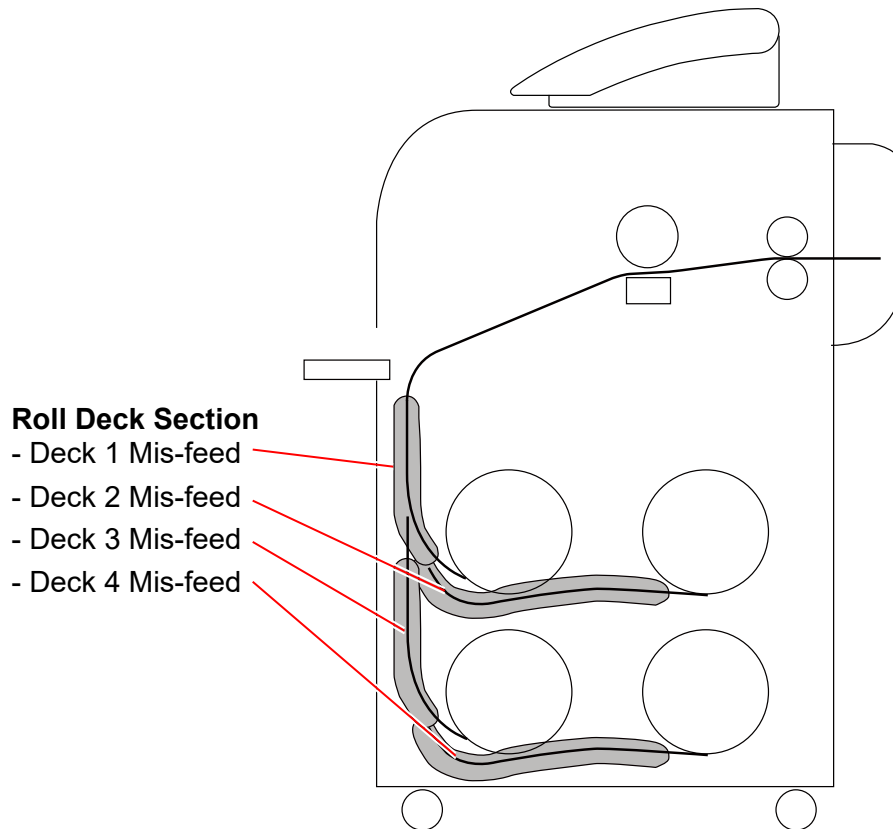

1. Pull the lever (1) to unlock the Roll Deck. Draw out the Roll Deck.



2. Rewind the roll media.

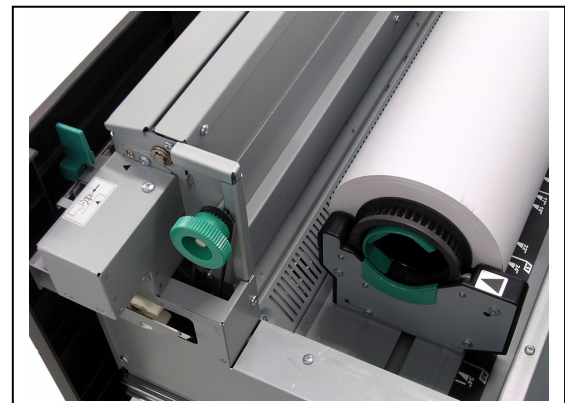
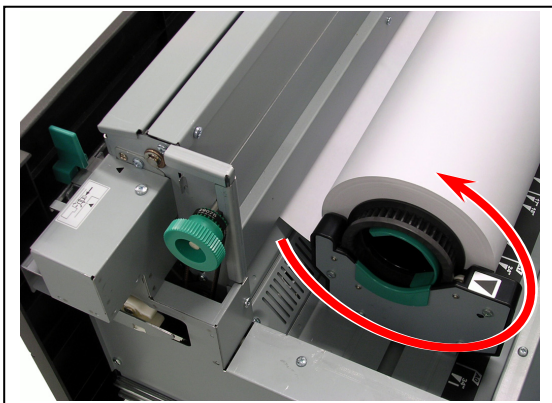

3. Insert the leading edge of the roll media under Guide Plate (2) until it touches the feeding roller. Rotate Feed Knob (3) clockwise so that the feeding rollers catch the leading edge.

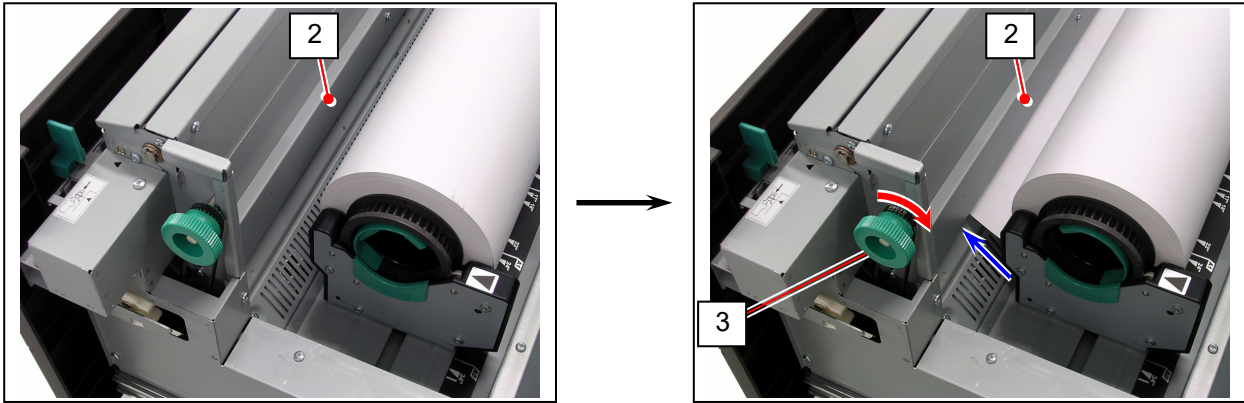

**! NOTE**

- (1) The leading edge should be trimmed with a cutter in case of an extreme crease.
- (2) Use the rear Feed Knob (4) for Roll Deck 2.

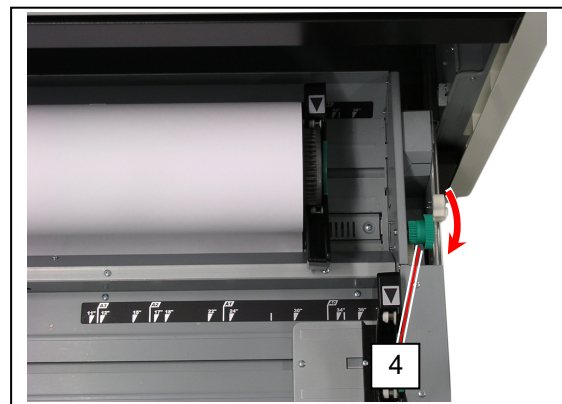

4. Hold the green grip (5: on the middle of Guide Plate) and turn Guide Plate outside. With holding, rotate Feed Knob (3) again so that the leading edge comes out in 100mm.

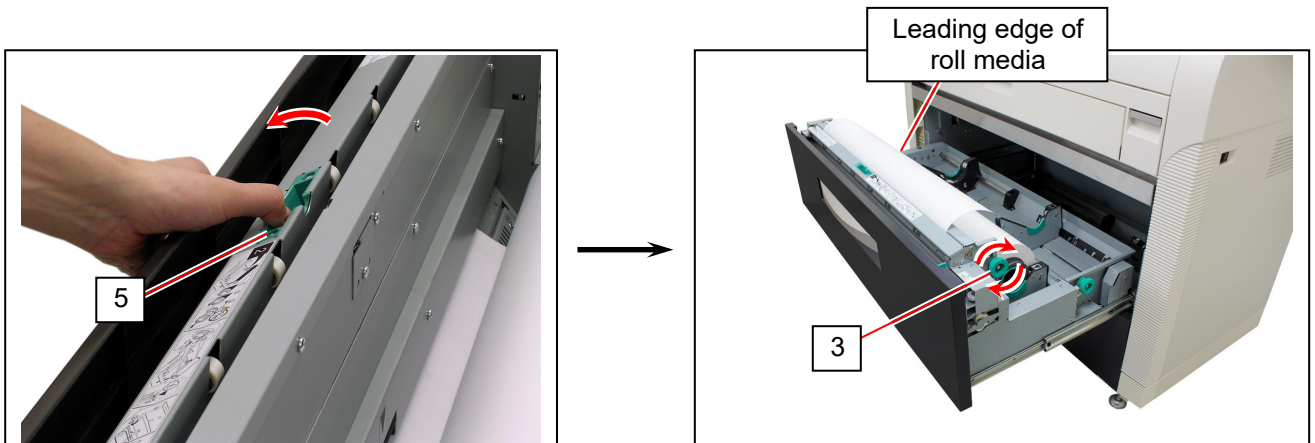

- Slide the green Cutter Knob (6) fully from one side to the other to make a new straight edge. Remove the cut portion.

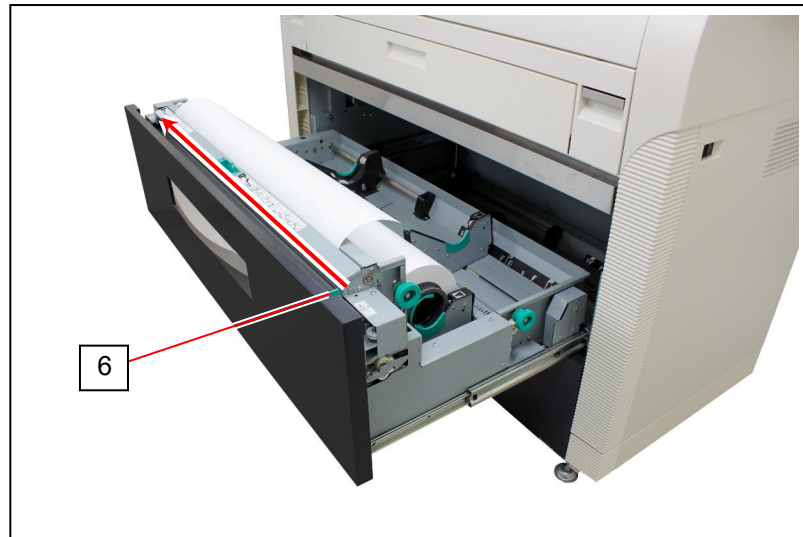

**! NOTE**

Completely slide Cutter Knob (6) until it stops at either end. Not doing so may cause a paper jam.

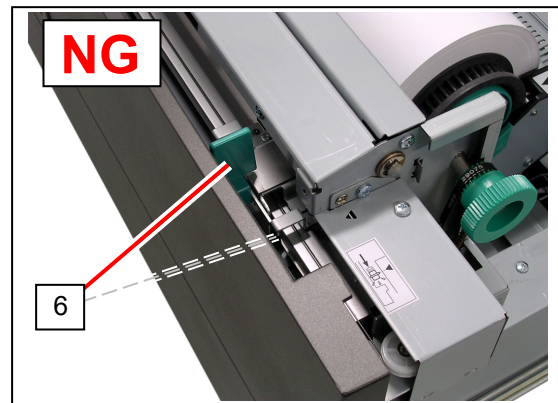
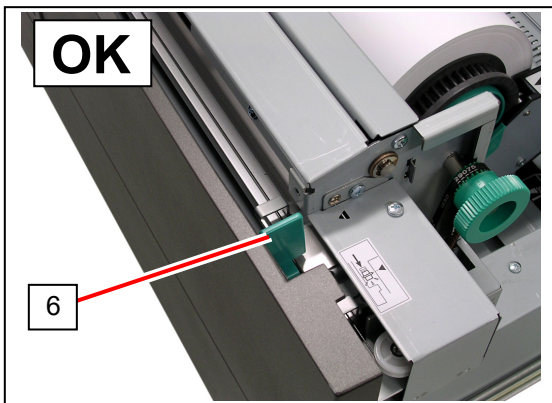

- Gently close Roll Deck.

**! NOTE**

Be sure to close the Roll Deck fully until it locks at the correct position. A paper jam may occur if it is not locked firmly.



### 3. 1. 2 Manual Feeder Section Jam (By-Pass Mis-feed)

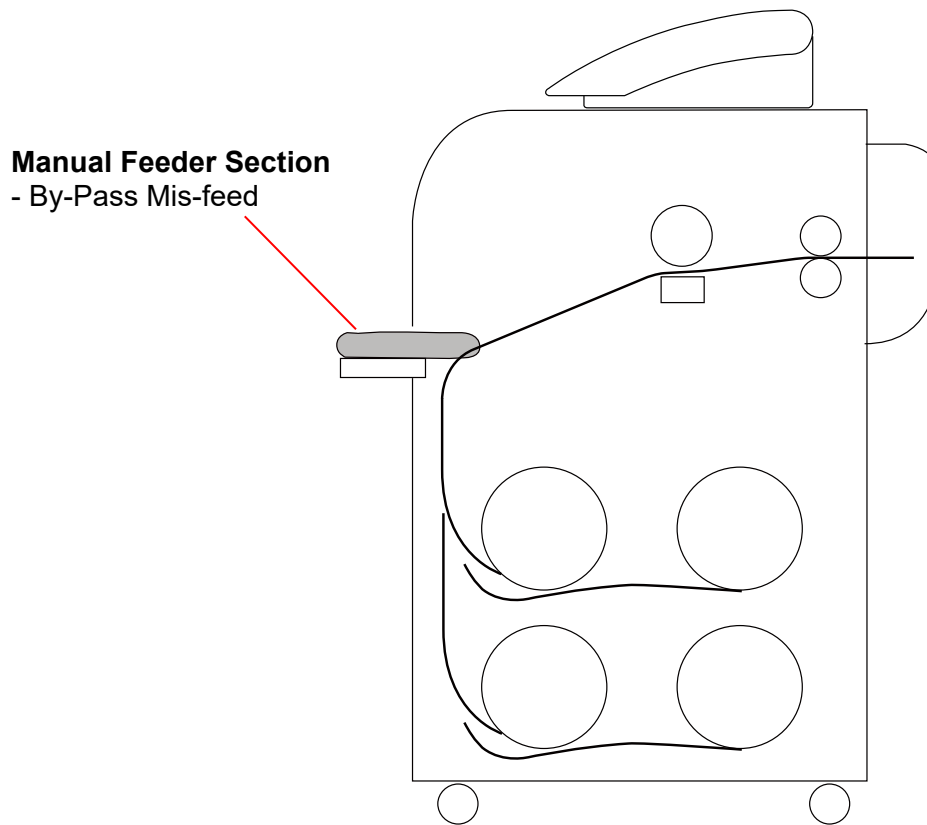

1. Remove all Print Trays (1).

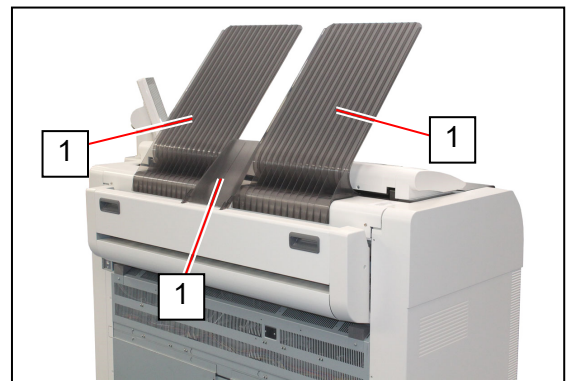

2. Pull up the Engine Unit Open Levers (2) to open the Engine Unit.



3. Remove the mis-fed paper pulling forward.



4. Gently close the Bypass Feeder and the Engine Unit.

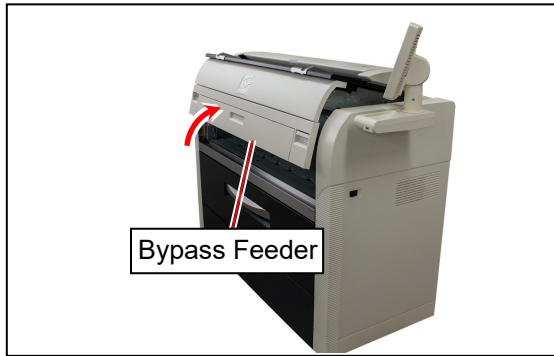

**! NOTE**

- (1) Be sure to close the Engine Unit firmly until it locks at the correct position.
- (2) The mis-feed cut sheet should be replaced with a new one if its leading edge has a torn or fold. Or it should be used upside down to keep the damaged edge from been inserted. An extremely creased cut sheet may cause mis-feed again.

5. Reinstall the Print Trays (1) to the original position.

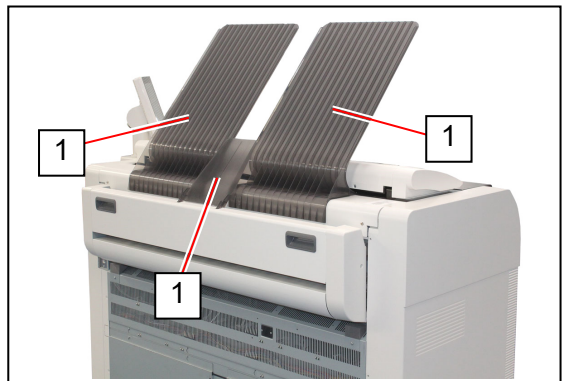

### 3. 1. 3 Media Feed Section Jam (Registration Mis-feed, Separation Mis-feed)

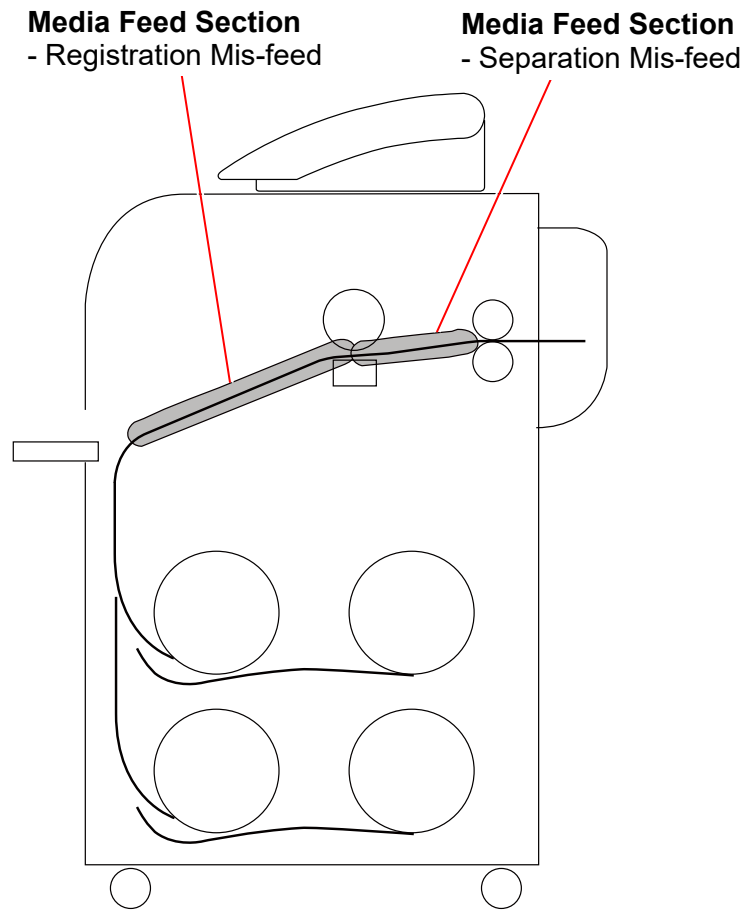

1. Remove all Print Trays (1).

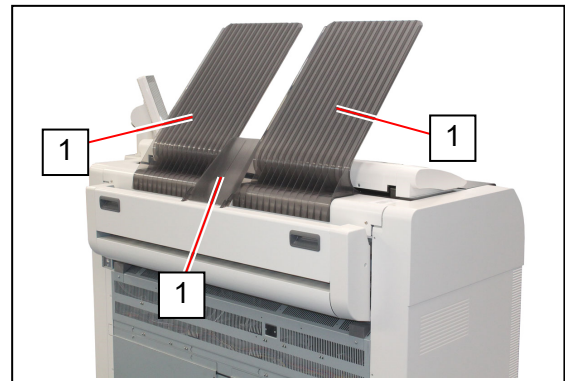

2. Pull up the Engine Unit Open Levers (2) to open the Engine Unit.





3. Remove the mis-fed paper.



4. Gently close the Engine Unit.



**! NOTE**  
Be sure to close the Engine Unit firmly until it locks at the correct position.

5. Reinstall the Print Trays (1) to the original position.

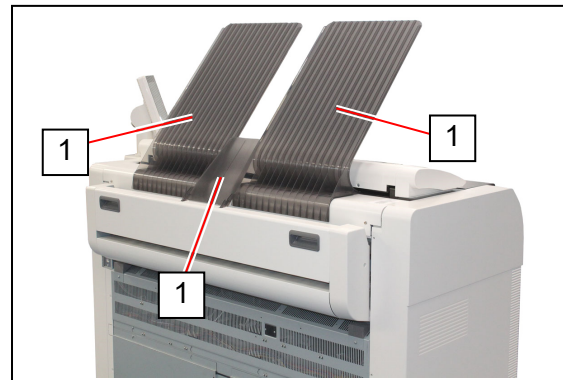

### 3. 1. 4 Fuser Section Jam (Exit Back Mis-feed)

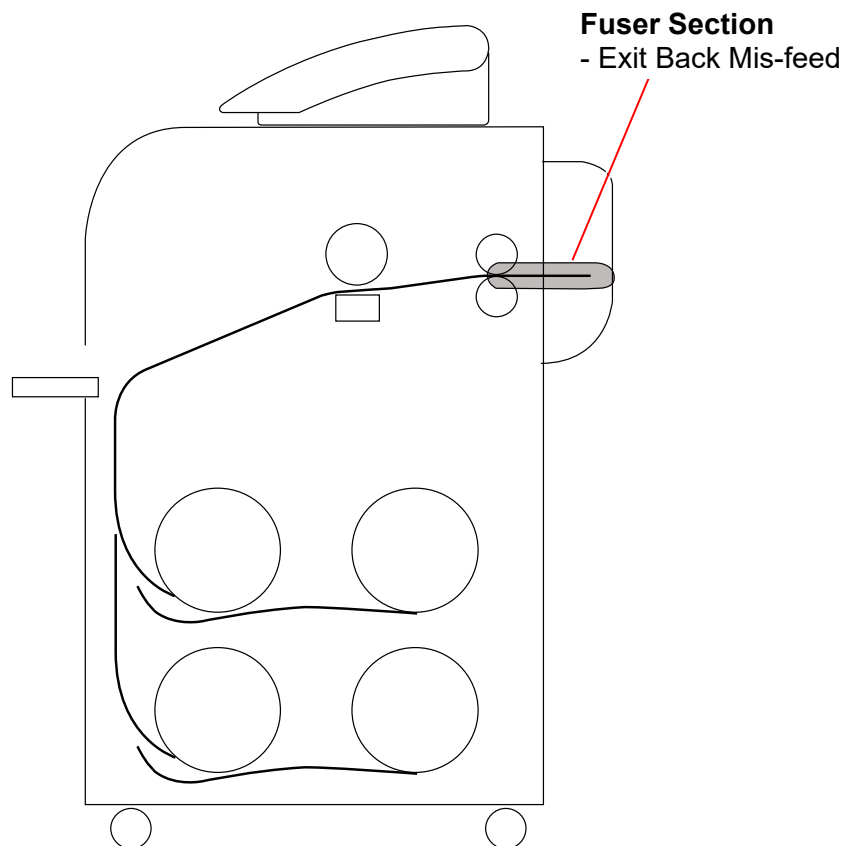

1. Remove all Print Trays (1).

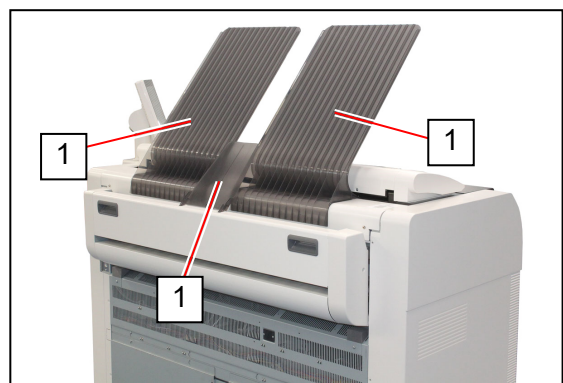

2. Pull up the Engine Unit Open Levers (2) to open the Engine Unit.

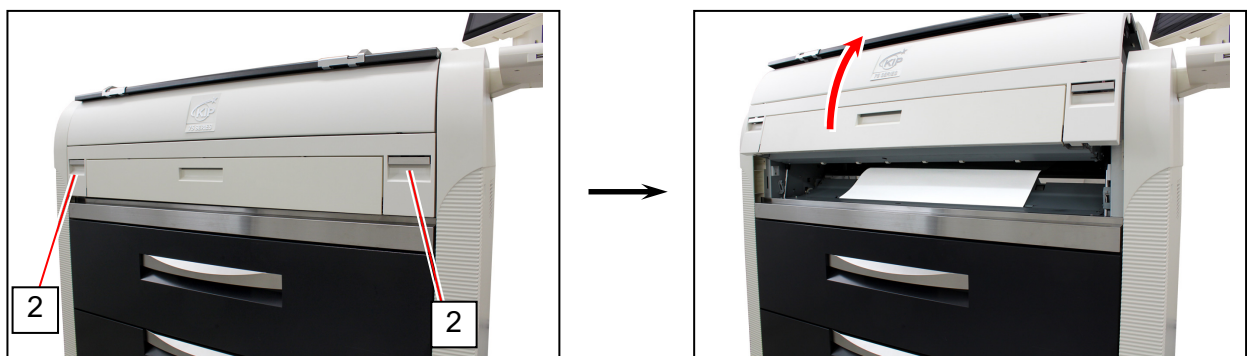

3. Remove the mis-fed paper.

If the mis-fed paper cannot be seen or removed, leave the media and go to the next step.

If the paper (including any torn part) can be removed, go to step 8.

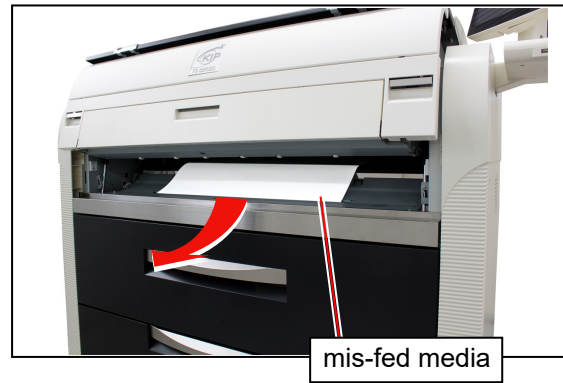

4. Hold the gray handles and open the Exit Cover (3).

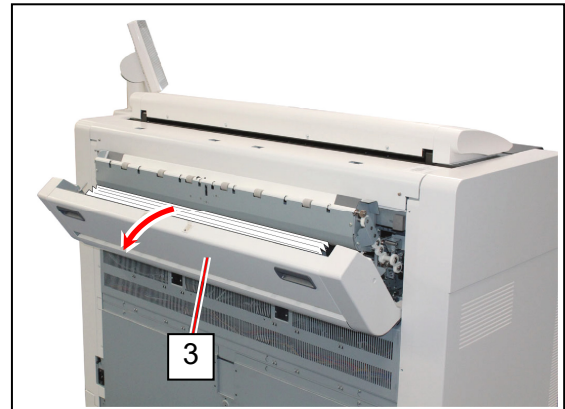
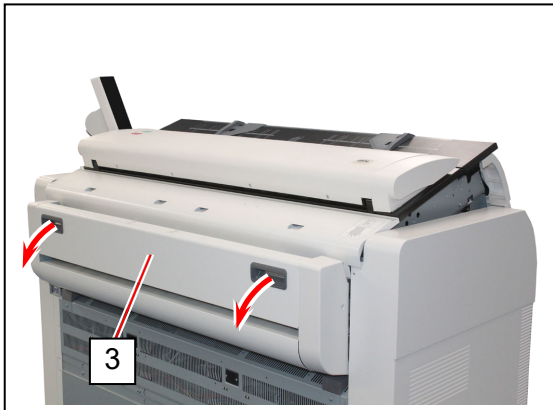

5. Pull and remove the jammed print to the rear.

If you remove the print at this time, just close the Exit Cover.  
If the print cannot be removed, go to the next step.

If the print (including any torn part) can be removed, go to step 8.

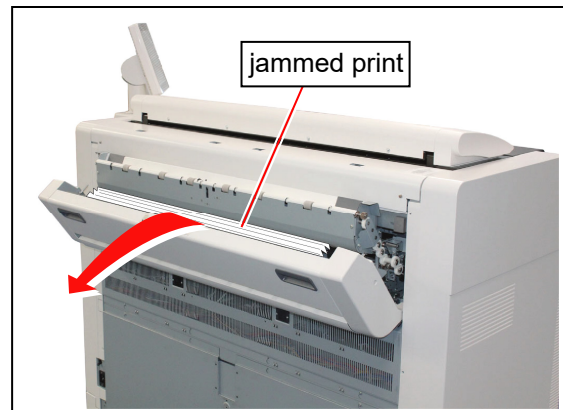

**⚠ WARNING**

Be careful not to get burnt when you touch the printing paper as it may be very hot.

**⚠ NOTE**

If removed a mis-fed paper inside the Fuser Door, scattered toner can be adhered to the next print.

6. Hold the gray areas (4) and release the Fuser Door (5).  
Pull and remove the jammed print to the rear.

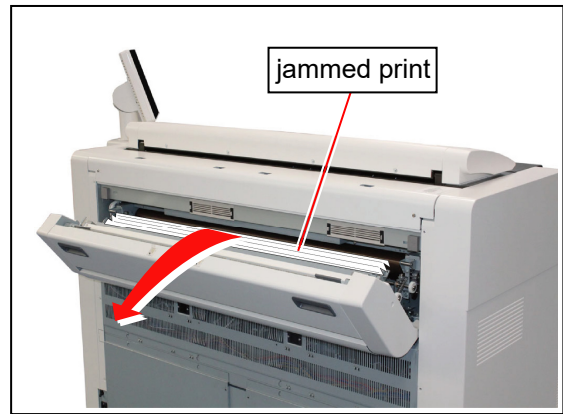
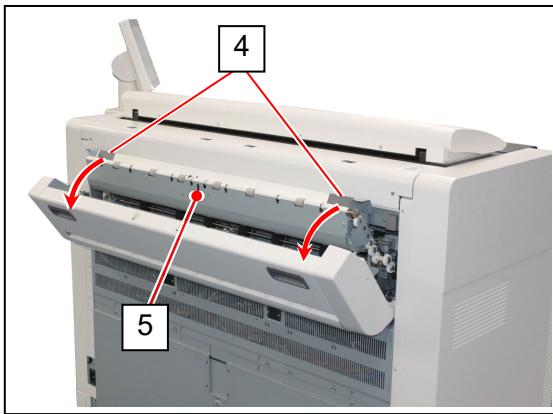

**! WARNING**

There are extremely hot parts inside the Fuser Door.  
Do not touch any parts in the Heater Unit, or you will be burnt.  
Also be careful not to get burnt when you touch the printing paper as it may be very hot.

**! NOTE**

If removed a mis-fed paper inside the Fuser Door, scattered toner can be adhered to the next print.

7. Close Fuser Door (5) and Exit Cover (3).

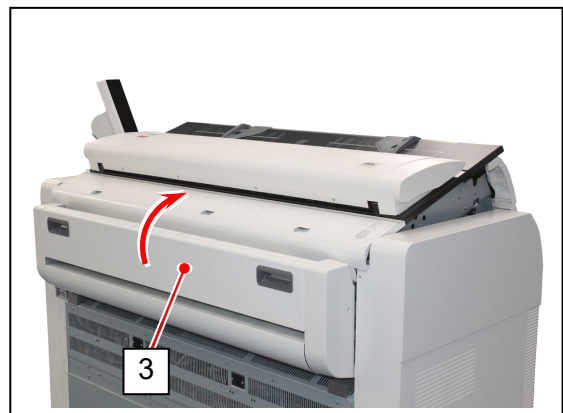
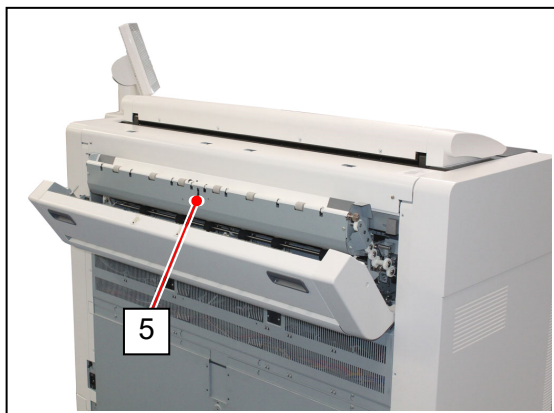

8. Gently close the Engine Unit.

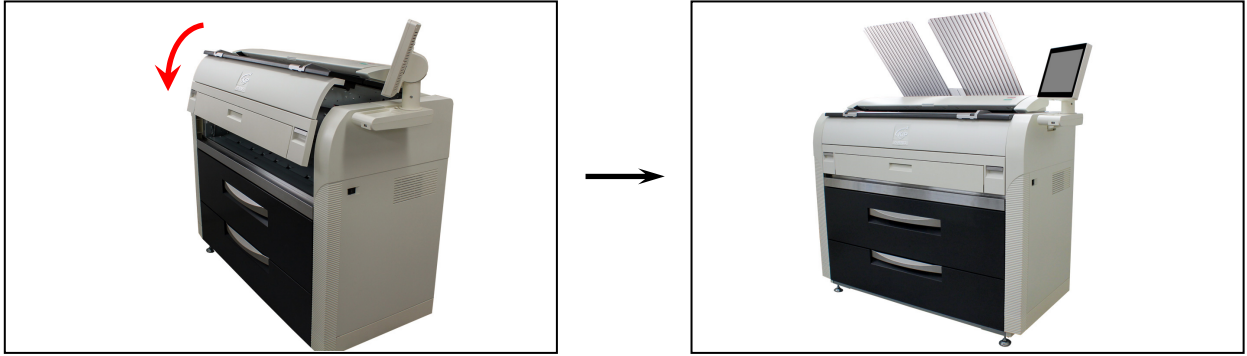

**! NOTE**

Be sure to close the Engine Unit firmly until it locks at the correct position.

9. Reinstall the Print Trays (1) to the original position.

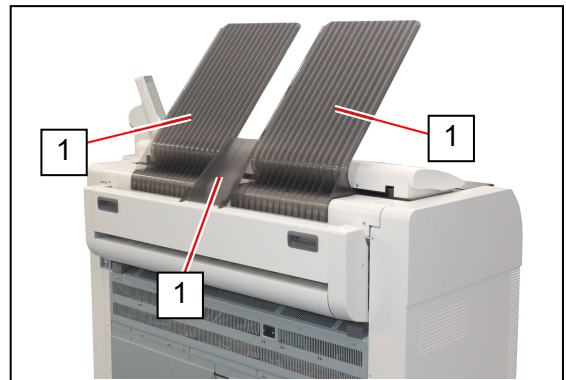



### 3. 1. 5 Stack Jam

1. Remove print(s) on Print Trays.



2. Remove all Print Trays (1).

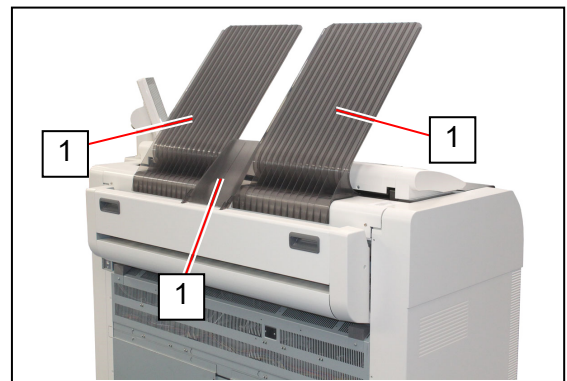

3. Pull up the Engine Unit Open Levers (2) to open the Engine Unit.



4. Pull and remove the jammed print to the top.

If the print cannot be removed, see [3.1.4 Fuser Jam] for the later procedure of clearing the jammed print.

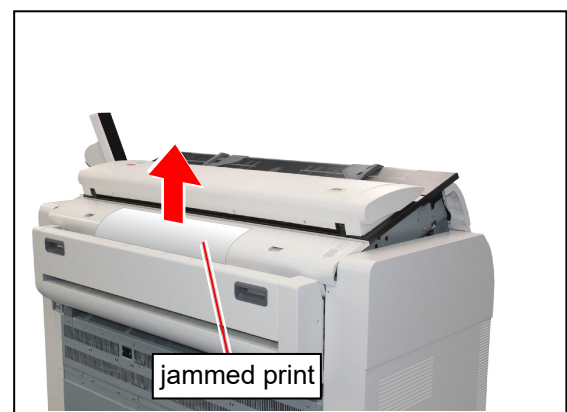

5. Gently close the Engine Unit.

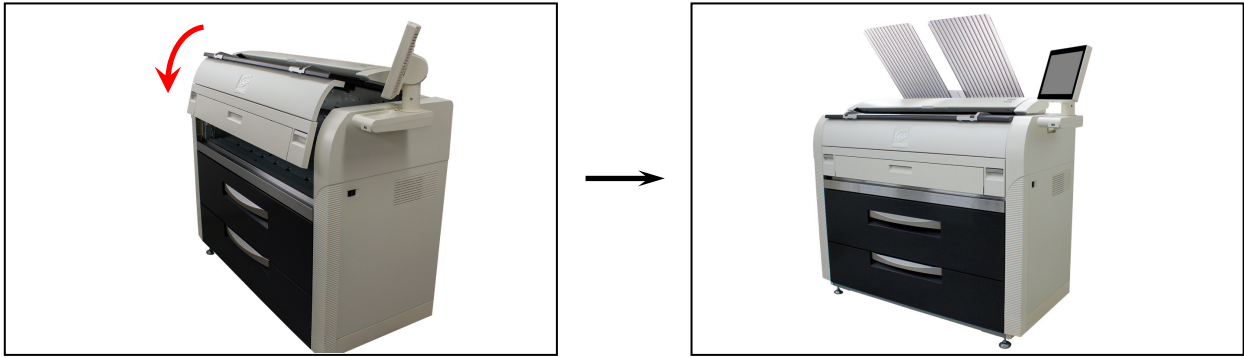

**! NOTE**

Be sure to close the Engine Unit firmly until it locks at the correct position.

6. Reinstall the Print Trays (1) to the original position.

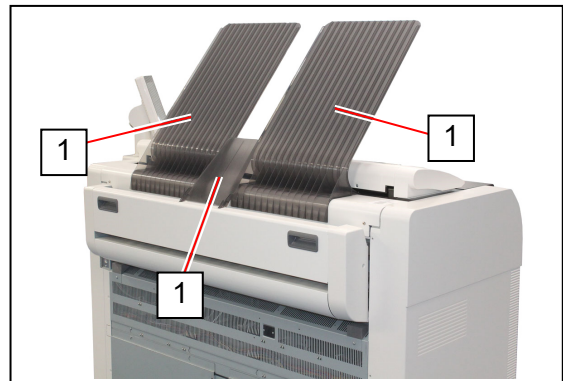

### 3. 1. 6 Original Jam (for MFP Model)

The scanner may stop feeding the original in the scanner if the original skews.  
Pressing Scan Abort Button during scanning also stops the original in the scanner.  
In both cases, LED Indicator flashes red.

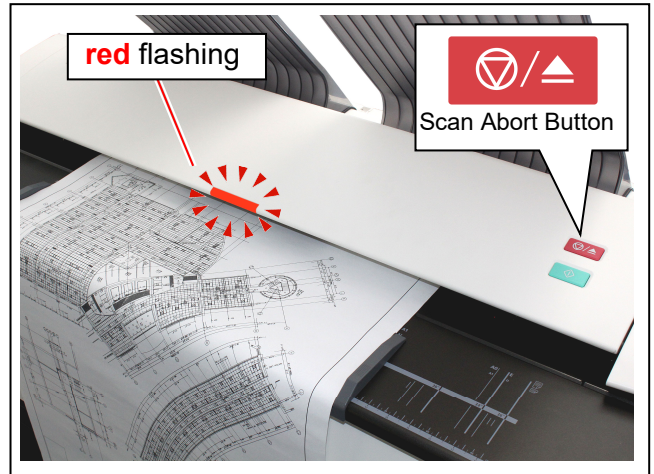

1. Lift up both sides (1) of the Scanner Unit, and then remove the original.

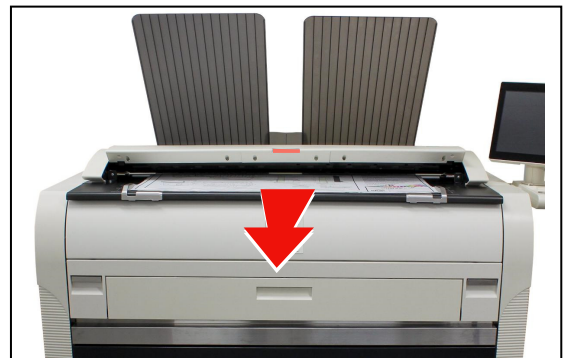
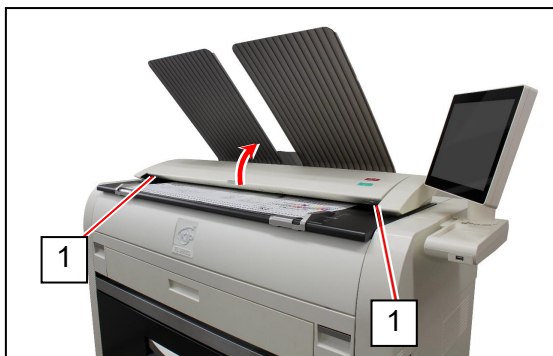

2. Gently press Scanner Unit down and firmly close it.



#### **!** NOTE

Press down Scanner Unit on both the sides to close it.  
Do not close it by pressing only one side down.



### **3. 1. 7    Accessory Jam**

The printing paper is mis-fed in the optional device such as Auto Stacker or Folder.  
Remove the mis-fed paper making reference to the User's Manual of concerning device.

## 3. 2 Door Open

---

"xxxx Open" is displayed in the UI screen when the door in each unit is opened.

### 3. 2. 1 Roll Deck (Deck 1 Open, Deck 2 Open)

Close the Roll Deck securely to clear "Deck 1 Open" or "Deck 2 Open".



### 3. 2. 2 Engine Unit (Front Cover Open)

Close the Engine Unit securely to clear "Front Cover Open".

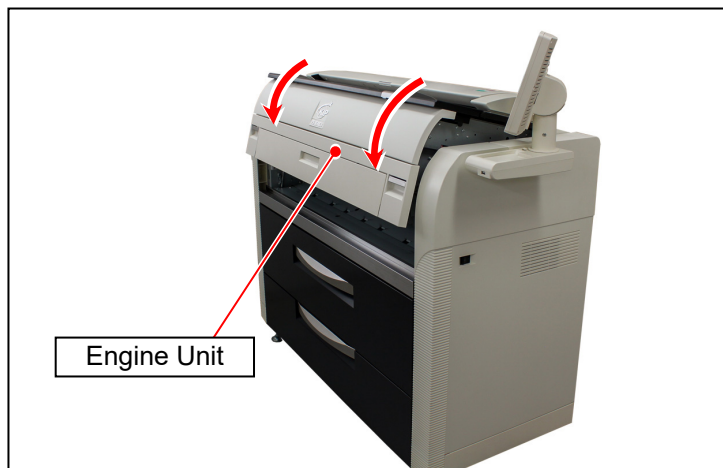

#### **!** NOTE

There is an interlock switch of the Engine Unit on both sides.  
In case that "Front Cover Open" is still displayed even when each door is closed securely,  
either interlock switch may be opened.  
For this case, open the Engine Unit once, and then close it securely.

### 3. 2. 3 Paper Exit Door (Paper Exit Door Open)

Close the Paper Exit Door securely to clear "Paper Exit Door Open".

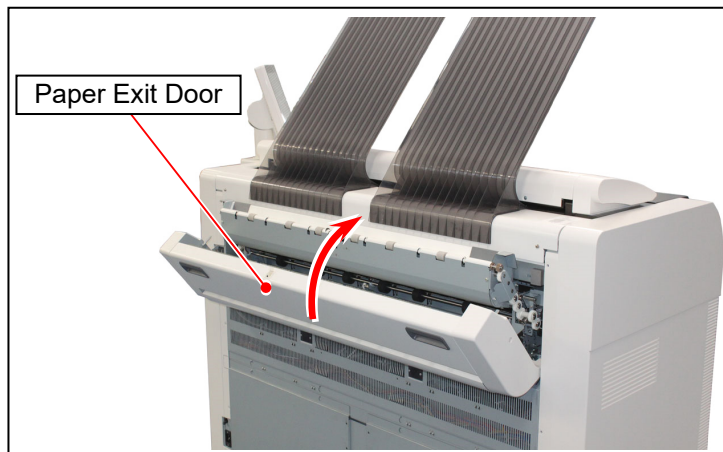

### 3. 2. 4 Scanner Unit (Scanner feeder open) (for MFP Model)

The UI screen shows "Scanner feeder open" if the Scanner Unit is open. (not closed properly)



## 3.3 Other Operator Call Error

---

### 3.3.1 Roll Replacement

When the printer is running out of a loaded roll media, the UI Screen will display “Out of Paper” sign.

If there is no suitable roll media required for the current print job, the UI Screen will display “Out of Paper” sign as well. Please load the required roll media to any Roll Deck.

**For the roll replacement procedure, see [2.3 Replacing Roll Media].**

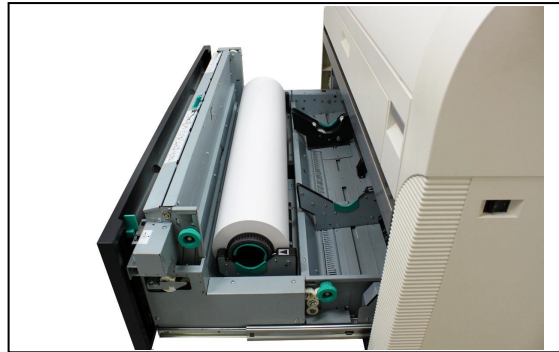

### 3.3.2 Toner Empty

When the printer is running out of toner, the UI Screen will display “Toner Empty” sign.

**For the toner supply procedure, see [2.4 Replacing Toner Cartridge].**

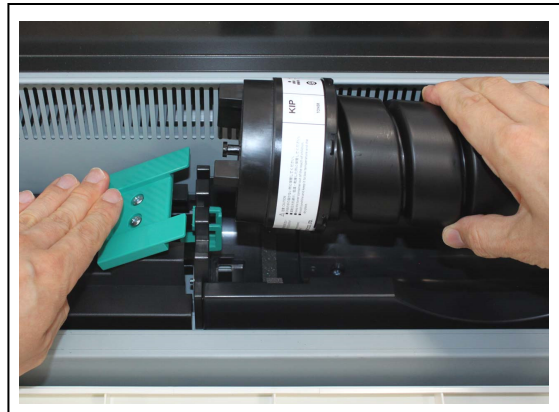

### 3.3.3 Accessory Error

If your finishing device (Auto Stacker, Folder) has an error, the UI screen of the printer would also show an error message.

**For clearing errors on such devices, see the concerning device’s User’s Manual.**

## 3.4 Service Call Errors

If an error with significant effect on the printer occurs, the printer stops the operation and indicates the related Service Call Error (Customer Engineer Call Error) in the UI screen. Call your service staff immediately as these problems can be fixed by a well trained technician only.

Before calling the service staff, cycle the power of the printer. If the error is indicated again, turn off the printer, unplug the power cord, and then call the service staff with reporting the error code “E-xxxx”.

- Fusing Temperature Error
- Motor Error
- Developer Error
- Counter Error
- Cutter Error
- Density Sensor Error
- High Voltage Power Supply Error

A corresponding code/description for the error will be displayed in the top column (status region) in the UI screen.

(E-0101 shown as example)

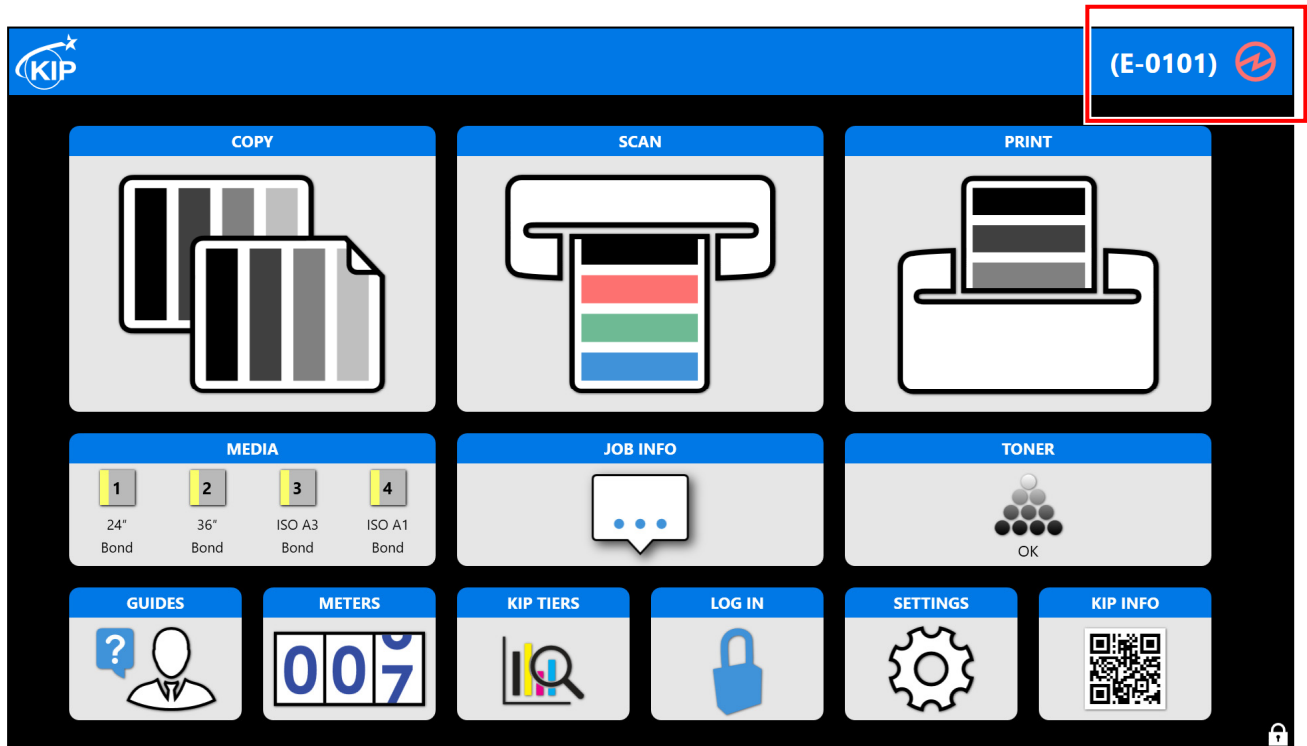

# Chapter 4

## Maintenance

	Page
<b>4.1 Scanner Unit (for MFP Model)</b> .....	4-2
4.1.1 Scan Glass, Feed Roller, Guide Plate .....	4-2
4.1.2 Sensor .....	4-5
<b>4.2 Touch Screen</b> .....	4-7

Before cleaning the printer, turn off the printer, wait two minutes for shutdown, and then disconnect the power cord from the wall outlet.

Wipe down the exterior surface with a soft, dry, clean cloth. To prevent the surface of your exterior cover from changing color, do not spray with or apply alcohol or the other volatile substances.

## 4. 1 Scanner Unit (for MFP Model)

---

### 4. 1. 1 Scan Glass, Feed Roller, Guide Plate

It is recommended to clean each Scan Glass, Feeding Rollers and Guide Plates as the scan/copy image may become defective if these parts are dirty.

#### **NOTE**

For ease of visual check, this document shows the Upper Unit fully open (not actual wide).

1. Turn off the Printer.
2. Lift up both sides (1) of the Scanner Unit.

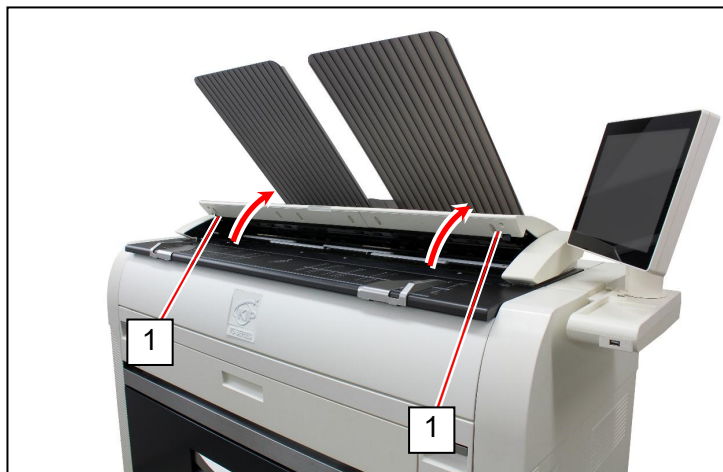



3. Gently wipe the Scan Glass (2) and Feed Rollers (white) (3) with a soft cloth. Equal mixture of water and neutral detergent can be used.

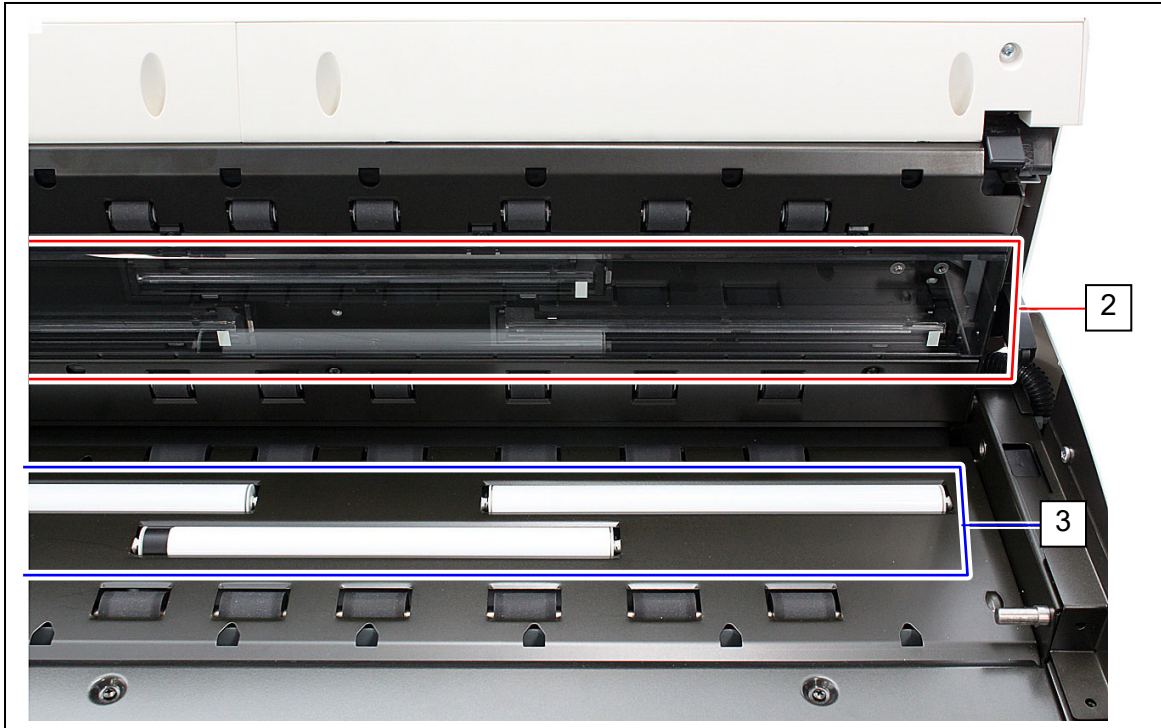

**⚠ NOTE**

Do not use organic solvent, glass cleaner and anti-static spray for the cleaning.

4. Wipe the Feed Rollers (rubber) (4) with a dry cloth.

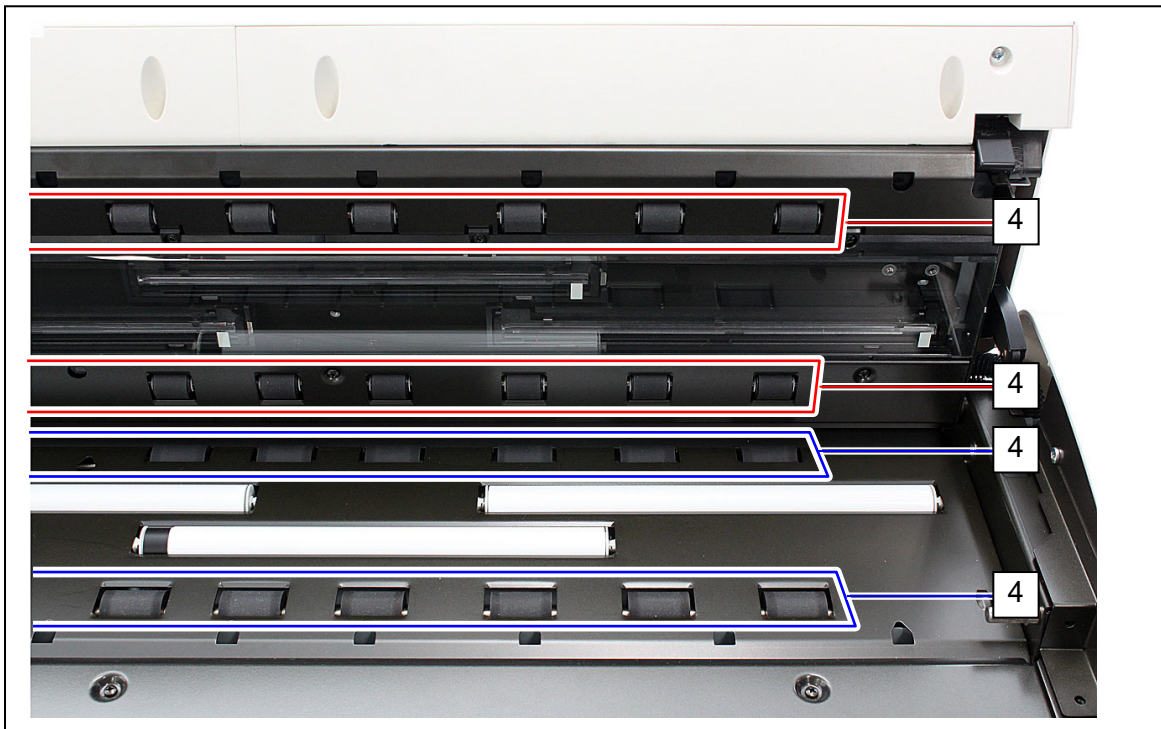

5. Wipe dry the Feeding Rollers.

6. Wipe the Upper Guide Plate (5) and the Lower Guide Plate (6) with a dry cloth.

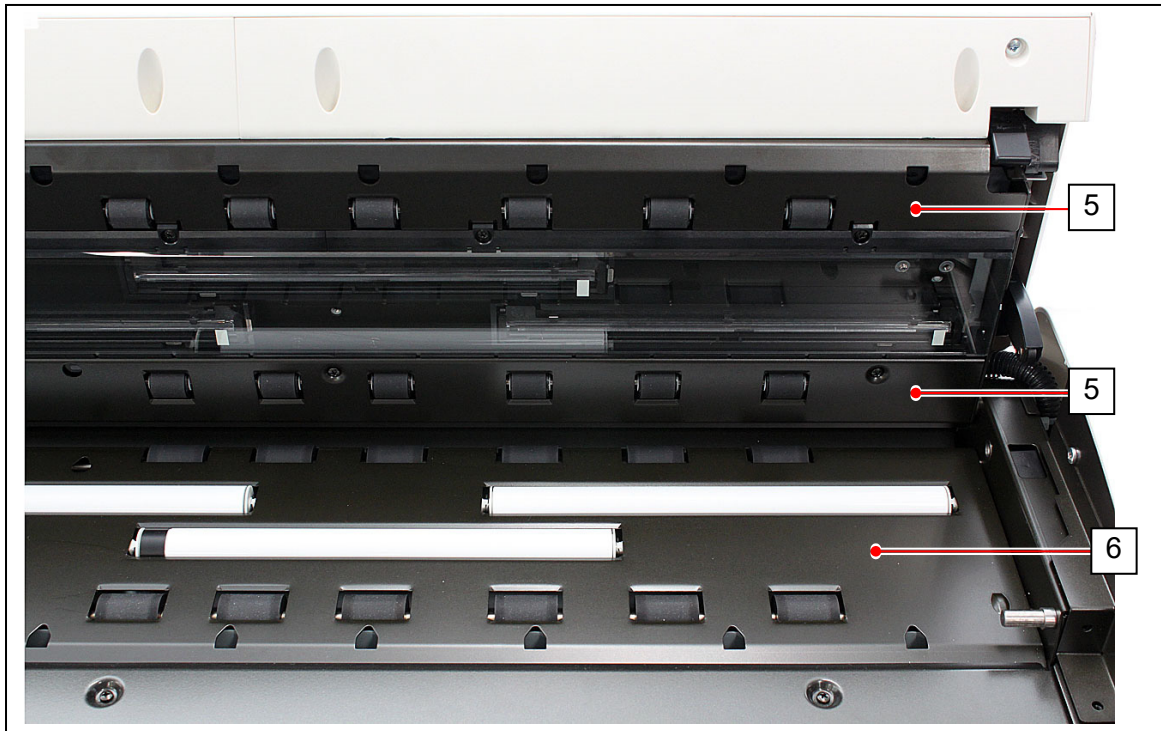

7. Gently press Scanner Unit down and firmly close it.



**⚠ NOTE**

Press down Scanner Unit on both side to close it.  
Do not close it by pressing only one side down.

## 4. 1. 2 Sensor

If Sensors are dirty, the original may be detected incorrectly.  
Perform cleaning or as needed.

### **!** NOTE

For ease of visual check, this document shows the Upper Unit fully open (not actual wide).

1. Turn off the Printer.
2. Lift up both sides (1) of the Scanner Unit.

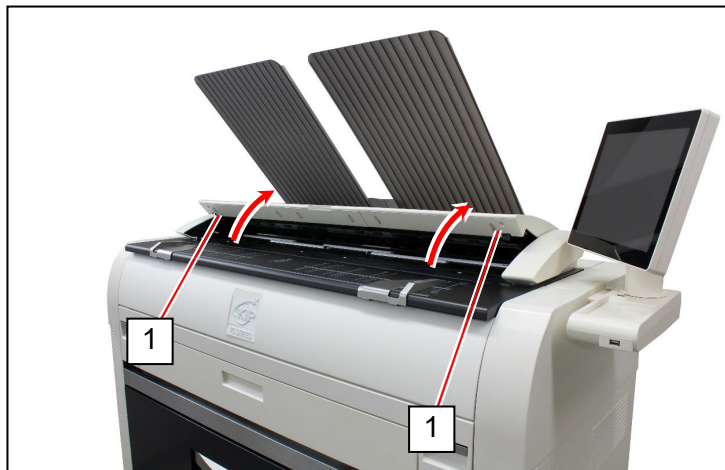



3. Gently wipe Sensors (2) with a dry cotton bud.

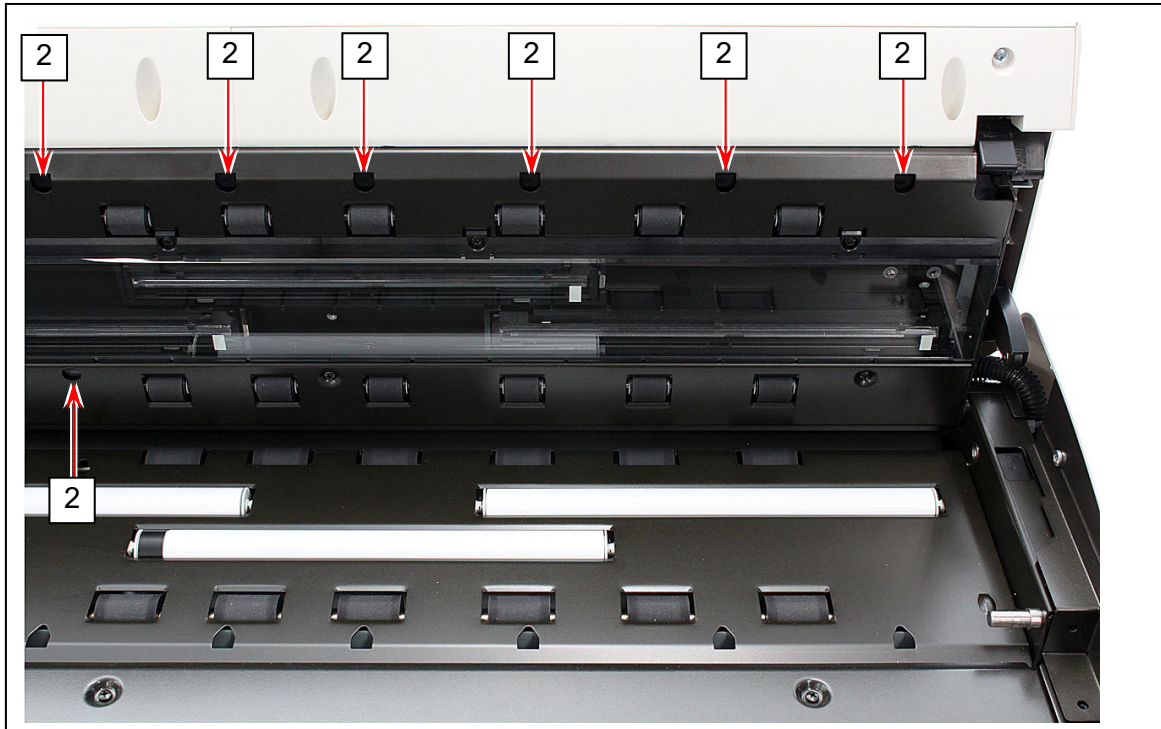

**! NOTE**

Do not use water, organic solvent, glass cleaner or antistatic spray for cleaning.

4. Gently press Scanner Unit down and firmly close it.



**! NOTE**

Press down Scanner Unit on both side to close it.  
Do not close it by pressing only one side down.

## 4.2 Touch Screen

---

1. Wipe the Touch Screen with a dry cloth.



**! NOTE**

Do not use water, alcohol, organic solvent and glass cleaner for the cleaning.

# KIP Global Network

America	
<b>America</b>	KIP America, Inc. 39575 W. 13 Mile Road Novi, MI 48377, U.S.A. Phone: +1-248-474-2900 <b>www.kip.com</b>
<b>Canada</b>	KIP Canada, Inc. 2735 Matheson Blvd. East, Suite 4, Mississauga, ON L4W 4M8, Canada Phone: +1-905-206-1177 <b>www.kip.com</b>
Europe	
<b>UK / Europe</b>	KIP Unit 8, Stephenson Close, Drayton Fields, Daventry, Northamptonshire, NN11 8RF, United Kingdom Phone: +44 (0) 1327 304 600 <b>www.kip.com</b>
Asia	
<b>Japan</b>	KIP Corporation 5-1 Yaguchi 1-Chome, Ota-ku, Tokyo 146-0093, Japan Tel: 03-3756-1101 <b>www.kip-net.co.jp</b>
<b>Hong Kong / Macao / Chinese mainland</b>	KIP Hong Kong Ltd. Unit 1508-9, 15/F, Tower A, Regent Centre, 63 Wo Yi Hop Road, Kwai Chung, N.T., Hong Kong Phone: 852 34269168
<b>Chinese mainland</b>	KIP (Beijing) Engineering Copying Equipments Co., Ltd. Room 21505, 12/F, Building 1, Xing Guang Global New Media Center, No.39 Chun He Road, Da Xing District, Beijing, China Phone: 86-10-60298900 <b>www.kipchina.com</b>
<b>Korea</b>	KIP Business Solution Korean Ltd. Room 1802, Halla Sigma Valley Bldg. 345-90, Gasan-dong, Geumcheon-gu, Seoul, 08588, Korea Phone: 82-2-785-8838 <b>www.kipkr.com</b>
<b>South Eastern Asia</b>	KIP Asia Co., Ltd. 200 Soi Baromratchachonnee 2 Bangbamru Bangkok, 10700, Thailand Phone: 662-4350022-6, 662-8818984-8 <b>www.kip-asia.com</b>
<b>Taiwan</b>	KIP Taiwan 108, Nan-Mei St., Kuei-Shan Taoyuan Phone: 886-3-321-0689 <b>www.kiptaiwan.com</b>

**WIDE FORMAT PRINTER /  
WIDE FORMAT MULTI FUNCTION PRINTER**

# **KIP 75 Series**

# **Hardware Operation Guide**

**Version A.0 (Issued on June 30, 2023)**

---

**Published by Katsuragawa Electric Co., Ltd.  
21-1 Shimomaruko 4-Chome,  
Ota-ku, Tokyo 146-8585, Japan**

---

Please note that some articles, illustrations and photographs might be partially different from the actual machine because of the modification of machine and so on.

© 2023 Katsuragawa Electric Co., Ltd.

No part of this publication may be copied, reproduced or distributed in any form without express written permission from Katsuragawa Electric Co., Ltd.